

SIMPLEMENTE ITALIANO



**ITALIANO/
ESPAÑOL**

**SPAGHETTI
(ESPAGUETI)**



DICCIONARIO EN IMÁGENES

EVI POXLEITNER

índice

[oficina / ufficio](#)

[casa / casa](#)

[comida / mangiare](#)

[fuera / fuori](#)

[cuerpo / corpo](#)

[emociones / emozioni](#)

[ropa / abbigliamento](#)

[animales / gli animali](#)

[familia / famiglia](#)

[estaciones del año / stagione dell'anno](#)

[números / i numeri](#)

[extras](#)

[diccionario](#)

[español - italiano](#)

[italiano - español](#)

[pie de imprenta](#)

SIMPLEMENTE ITALIANO



**ITALIANO/
ESPAÑOL**

**SPAGHETTI
(ESPAGUETI)**



DICCIONARIO EN IMÁGENES

EVI POXLEITNER

oficina / ufficio

(COMPUTADOR)
COMPUTER

(PARLANTE)
ALTOPARLANTE

(PANTALLA)
SCHERMO

(CEDÉ)
CD

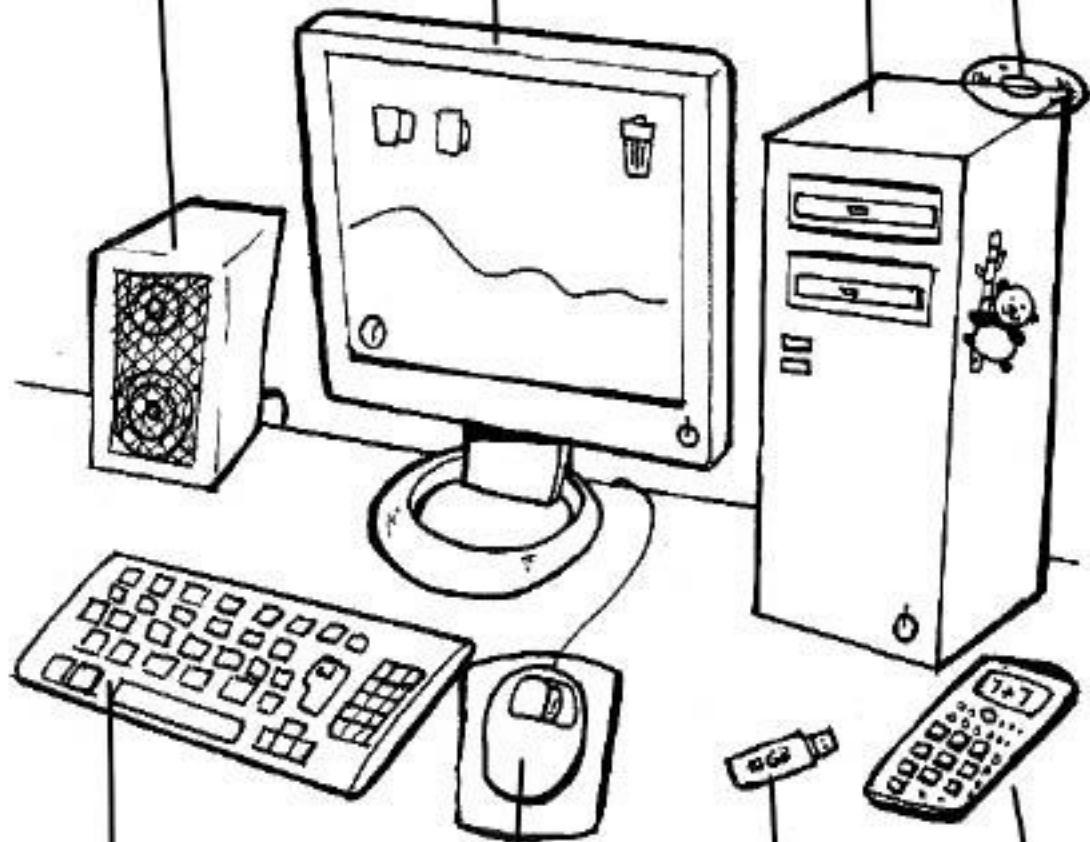

TASTIERA
(TECLADO)

CHIAVE USB
(MEMORIA USB)

CALCOLATRICE
(CALCULADORA)

MOUSE
(RATÓN DEL ORDENADOR)

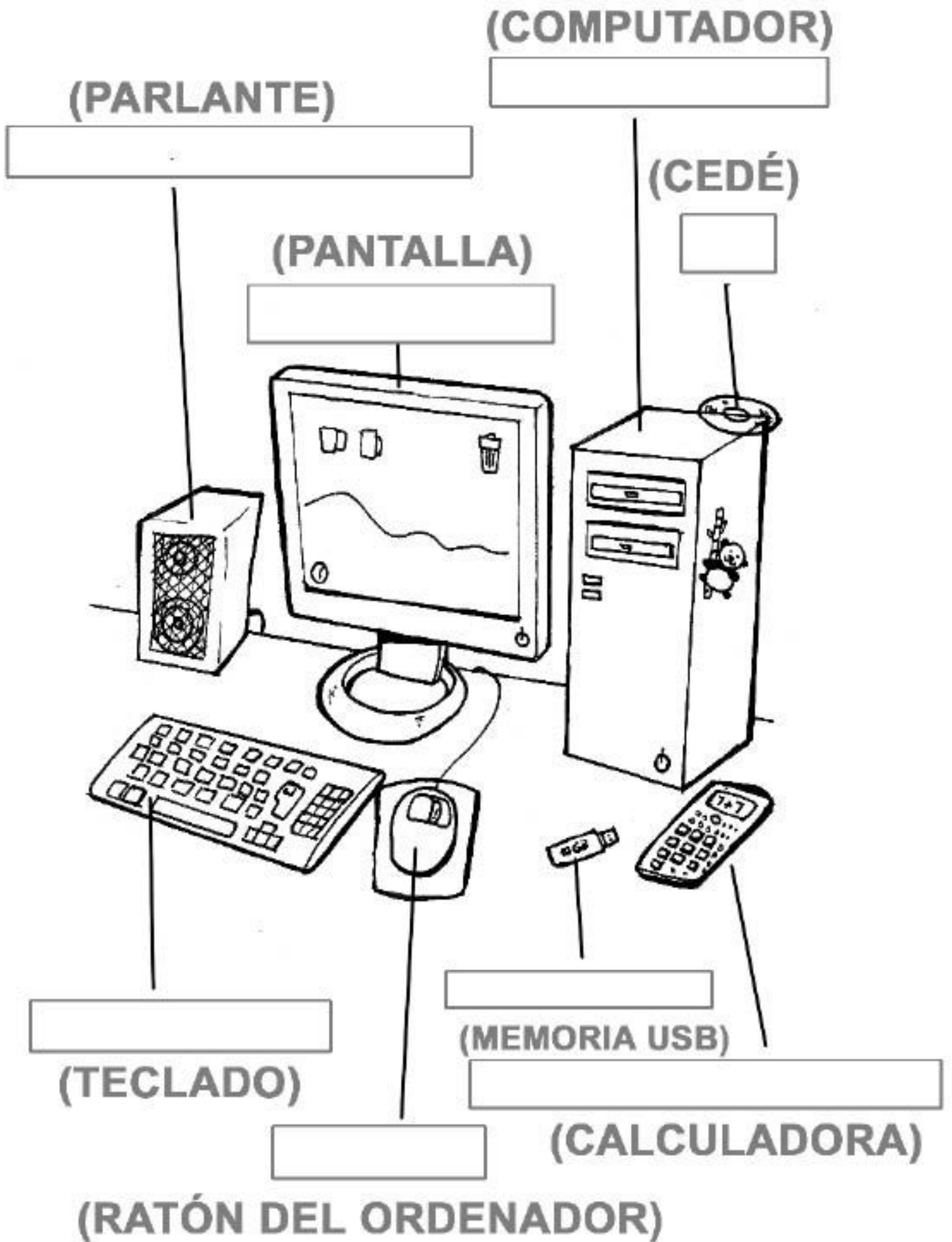

COMPUTER

ALTOPARLANTE

CD

SCHERMO

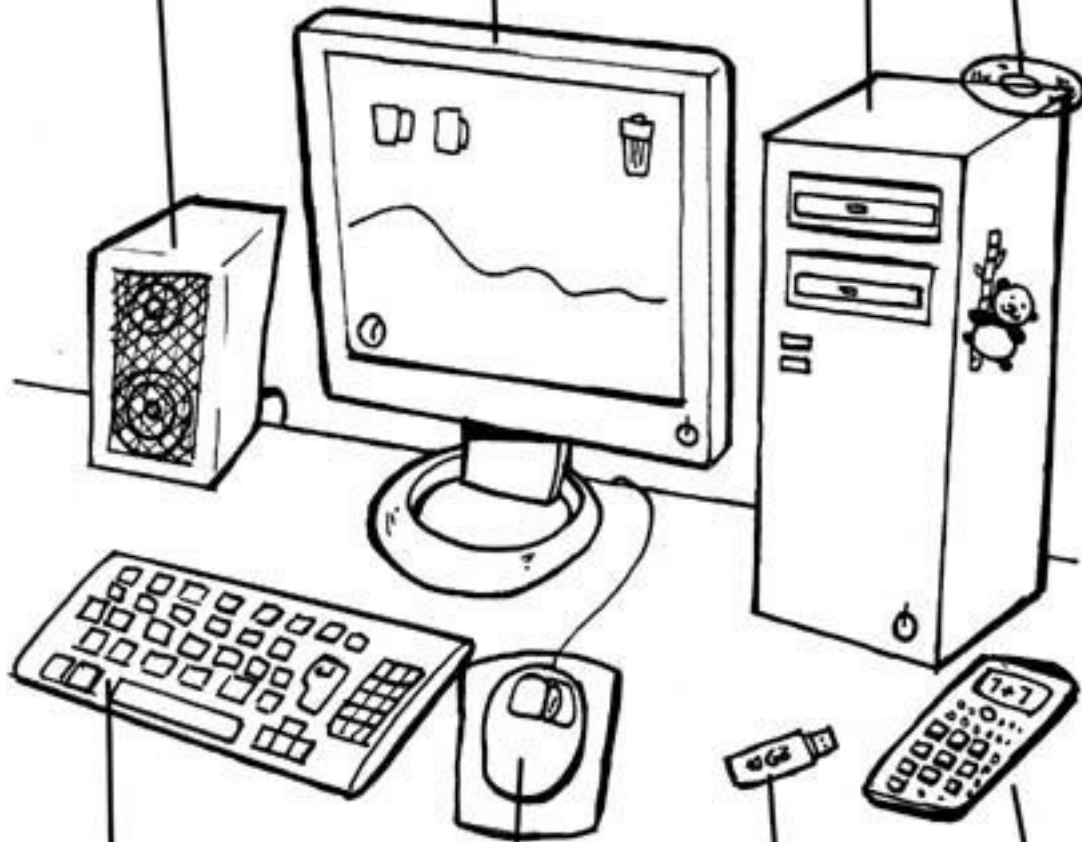

TASTIERA

CHIAVE USB

CALCOLATRICE

MOUSE

(LAPICERO)

PENNA BIRO

(PAPELETA)

CARTA

(ADHESIVO)

ADESIVO

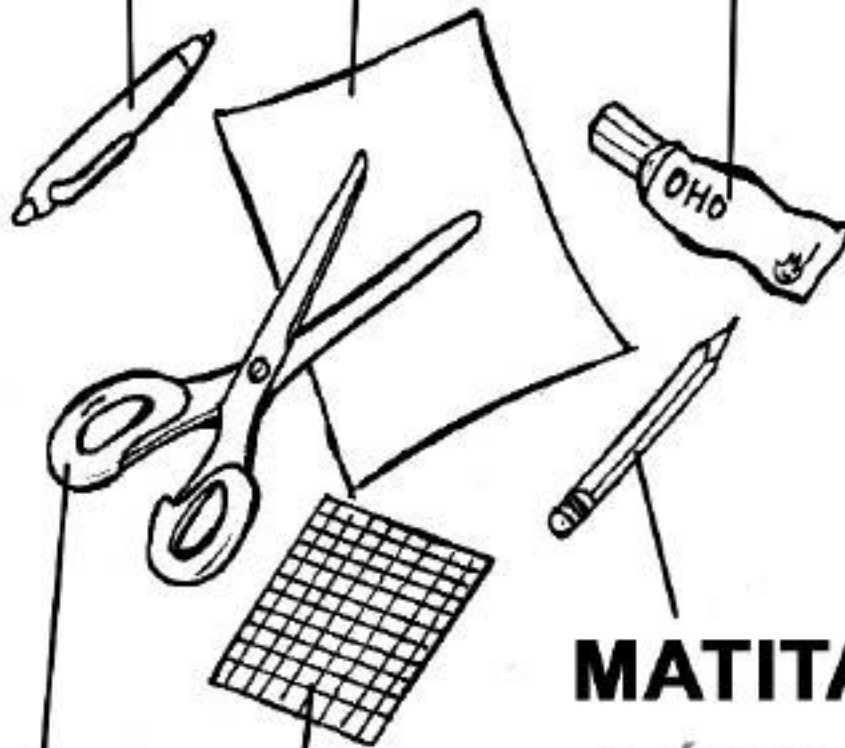

MATITA

(LÁPIZ)

FORBICE

(TIJERA)

CARTA MILLIMETRATA

(PAPEL A CUADROS)

(LAPICERO)



(PAPELETA)



(ADHESIVO)

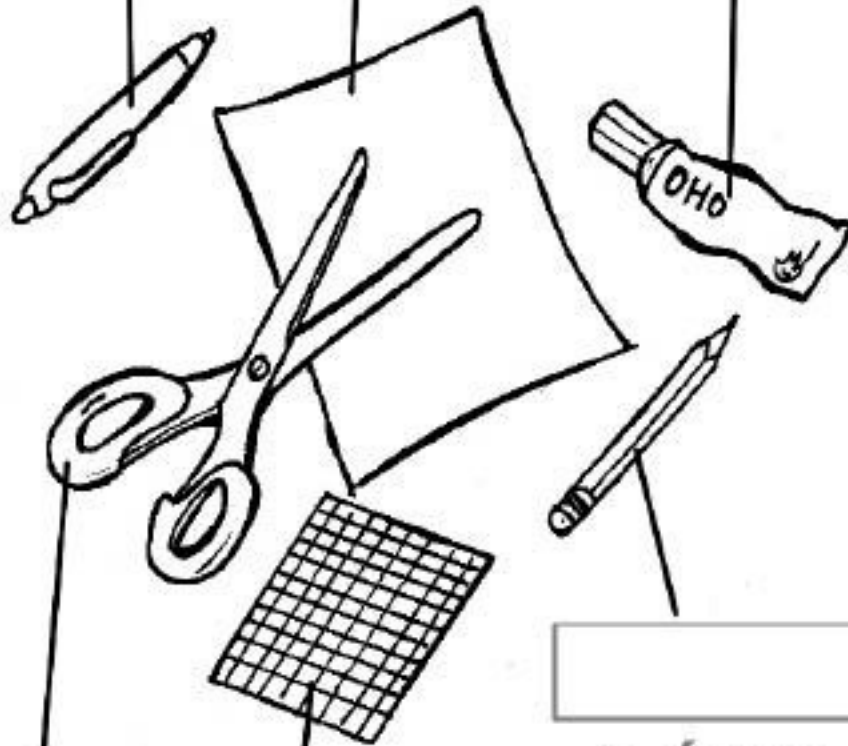

(LÁPIZ)



(TIJERA)



(PAPEL A CUADROS)



PENNA BIRO

CARTA

ADESIVO



MATITA

FORBICE

CARTA MILLIMETRATA

(TELEFÓNICO)

TELEFONO

(BURÓ)

SCRIVANIA

(CABLE)

CAVO



CESTINO
(PAPELERA)



PRESA
(BASE)

(TELEFÓNICO)



(BURÓ)



(CABLE)



(PAPELERA)

(BASE)

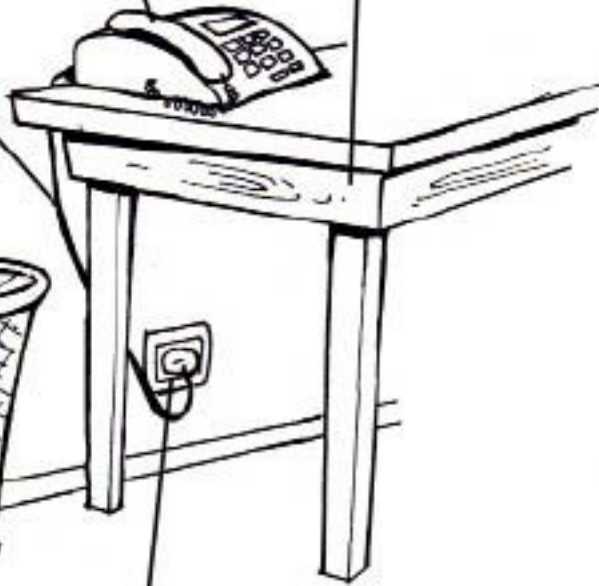

TELEFONO

SCRIVANIA

CAVO

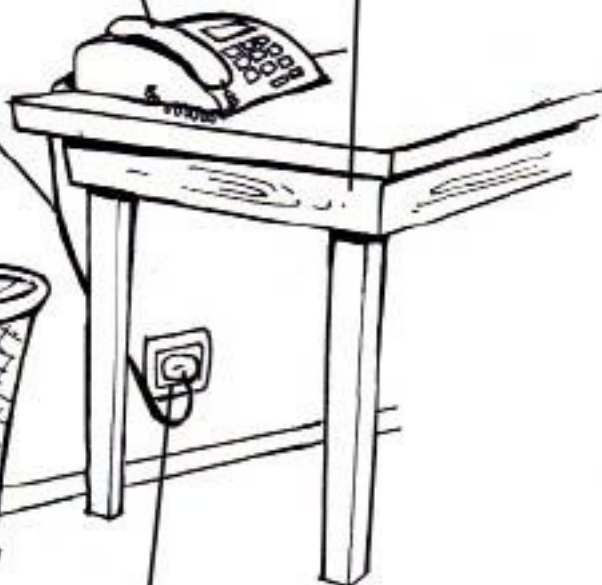

PRESA

CESTINO

casa / casa



(VENTANA)



(CROMO)



(CORTINA)



(ALMOHADA)

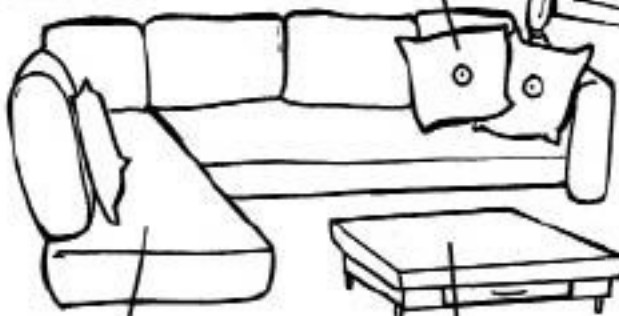

(SOFÁ)



(MESA AUXILIAR)

FINESTRA

DIPINTO

CORTINA

CUSCINO

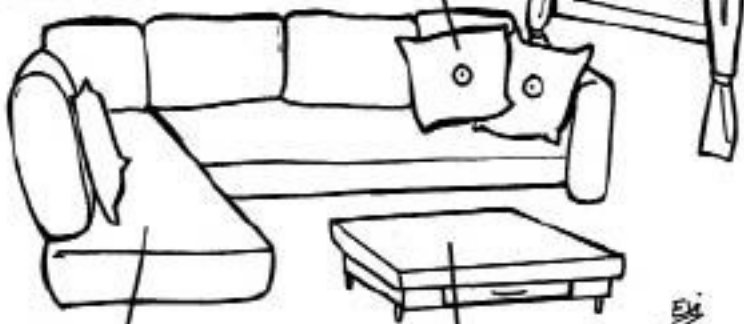

SOFA

TAVOLINO

(TELEVISIÓN)
TELEVISORE

(LÁMPARA)
LAMPADA

(PLANTA)
PIANTA

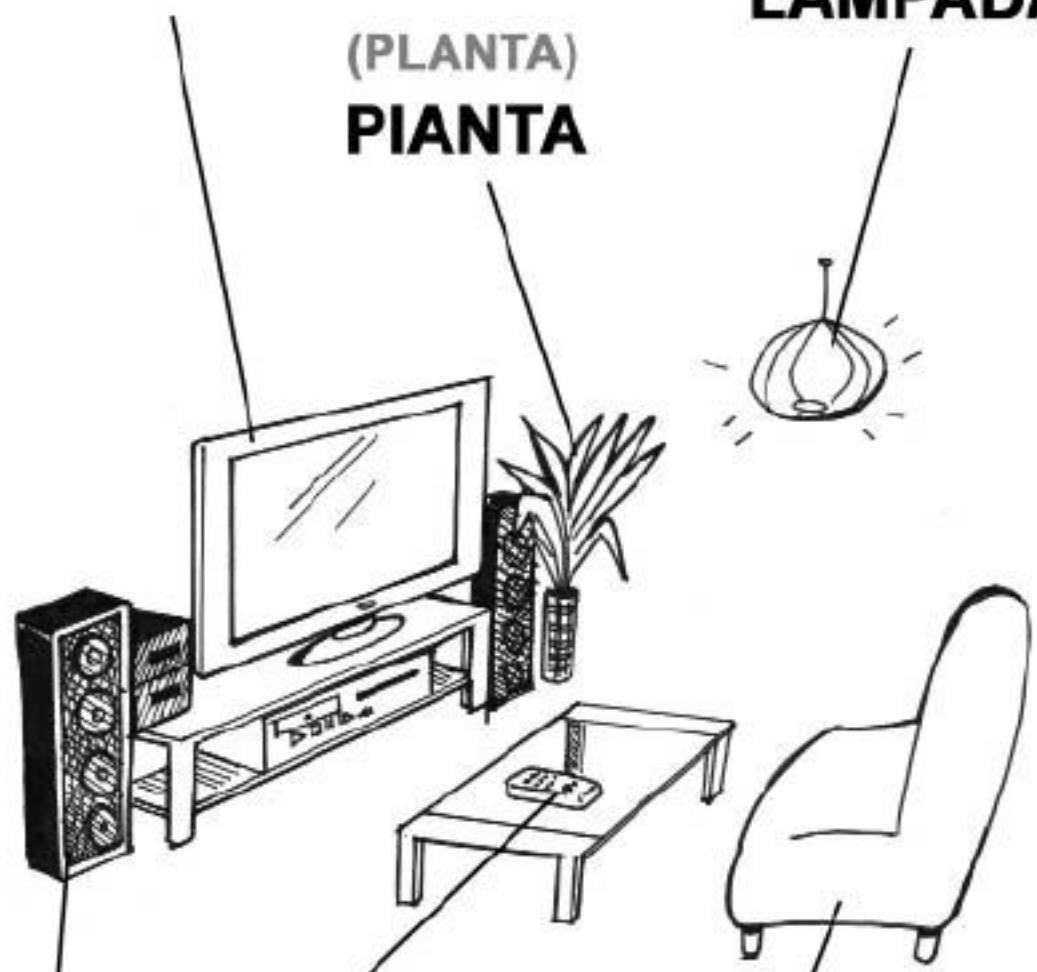

TELECOMANDO
(TELECOMANDO)

STEREO

POLTRONA

(APARATO DE MÚSICA)

(SILLÓN)

(TELEVISIÓN)



(LÁMPARA)



(PLANTA)



(TELECOMANDO)



(APARATO DE MÚSICA)



(SILLÓN)



TELEVISORE

LAMPADA

PIANTA



TELECOMANDO

STEREO

POLTRONA

(MICROONDA)
MICROONDA

(CAMPANA DE
EXTRACCIÓN
DE GASES)

(GRIFO)
RUBINETTO

CAPPA

(HORNO)

FORNELLO

CASSETTO
(CAJÓN)

FORNO
(ESTUFA)

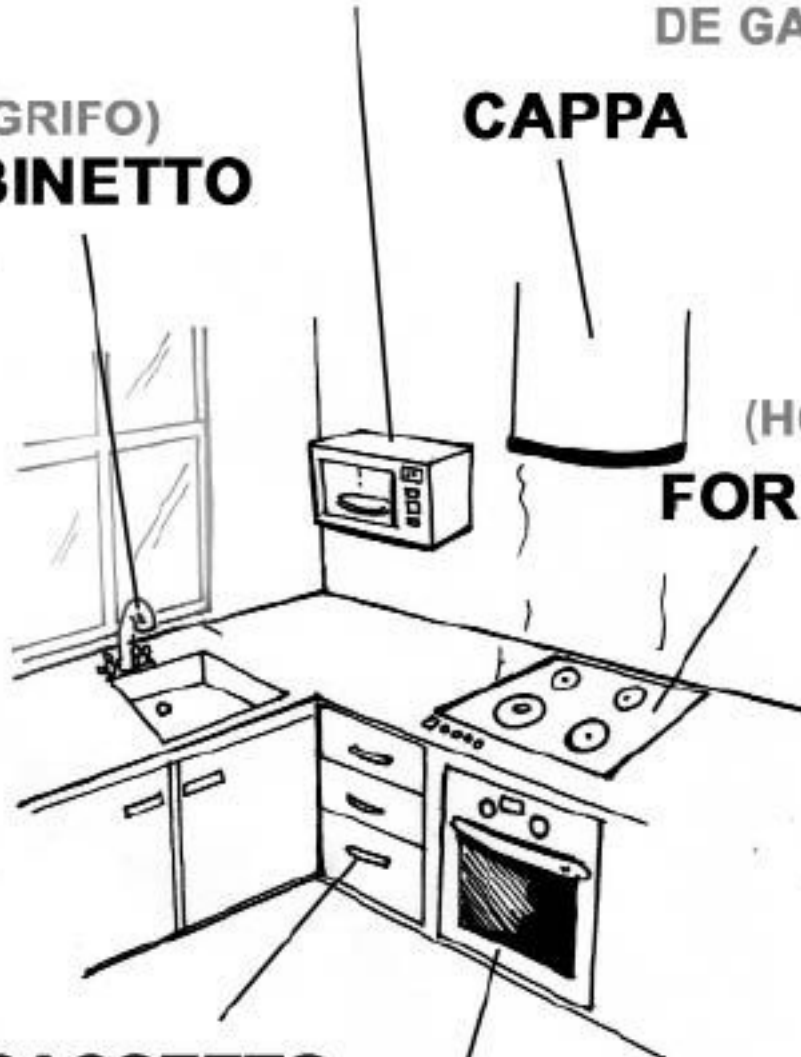

(MICROONDA)



(CAMPANA DE
EXTRACCIÓN
DE GASES)

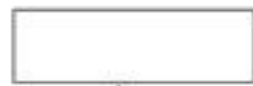

(GRIFO)



(HORNO)



(CAJÓN)

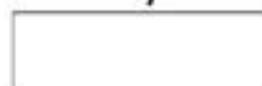

(ESTUFA)

MICROONDA

CAPPA

RUBINETTO

FORNELLO

CASSETTO

FORNO

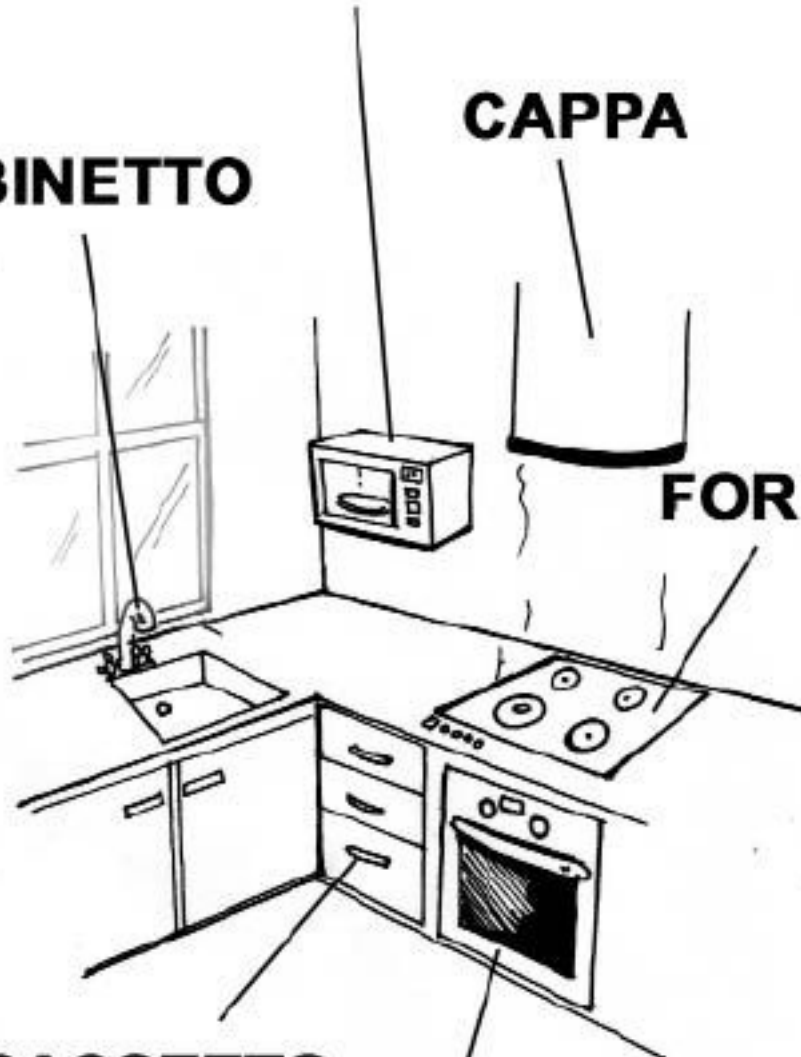

(ZAPATO)

SCARPA

(BOTELLA)

BOTTIGLIA

(LIBRO)

LIBRO



LETTERA

(CARTA)

CANDELA

(VELA)

TIMBRO

(ESTAMPILLA)

(ZAPATO)



(BOTELLA)



(LIBRO)



(CARTA)



(VELA)



(ESTAMPILLA)



SCARPA

BOTTIGLIA

LIBRO



LETTERA

CANDELA

TIMBRO

(PASTA DE DIENTES)

DENTIFRICIO

(DIENTE)
DENTE



**SPAZZOLINO
DA DENTI**
(CEPILLO
DE DIENTES)



OCCHIALI
(GAFAS)

SPAZZOLA PER CAPELLI
(CEPILLO)

(PASTA DE DIENTES)

(DIENTE)



(CÉPILLO DE DIENTES)



(GAFAS)

(CÉPILLO)

DENTIFRICIO

SPAZZOLINO
DA DENTI

DENTE



OCCHIALI

SPAZZOLA PER CAPELLI

(ROSA) ROSA

FIORE
(FLOR)

VASO
(FLORERO)



PENTOLA
(CALDERO)

PADELLA
(CAZUELA)

(ROSA)

(FLOR)

(FLORERO)



(CALDERO)

(CAZUELA)

ROSA

FIORE

VASO



PENTOLA

PADELLA

LAMPADA (LÁMPARA)

(ALMOHADA)

CUSCINO

(COLCHA)

COPERTA DA LETTO



LETTO

(CALMA)

MATERASSO

(COLCHÓN)

[] (LÁMPARA)

(ALMOHADA)

[]

(COLCHA)

[]



[]

(CALMA)

[]

(COLCHÓN)

LAMPADA

CUSCINO

COPERTA DA LETTO



LETTO

MATERASSO

(ESPEJO)
SPECCHIO

(TOALLA)

ASCIUGAMANO (SERVICIO)

TOILETTE

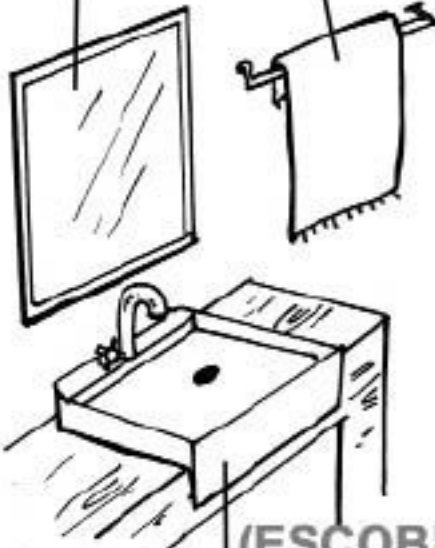

(ESCOBILLA DE RETRETE)
**SCOPINO DEL
GABINETTO**

**LAVANDINO
(LAVABO)**

**CARTA IGIENICA
(PAPEL HIGIÉNICO)**

(ESPEJO)



(TOALLA)



(SERVICIO)

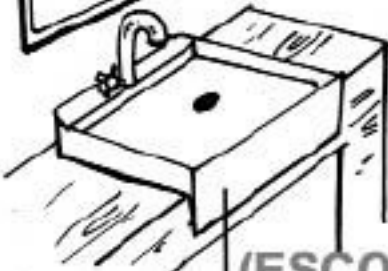

(ESCOBILLA DE RETRETE)



(LAVABO)



(PAPEL HIGIÉNICO)

SPECCHIO

ASCIUGAMANO

TOILETTE

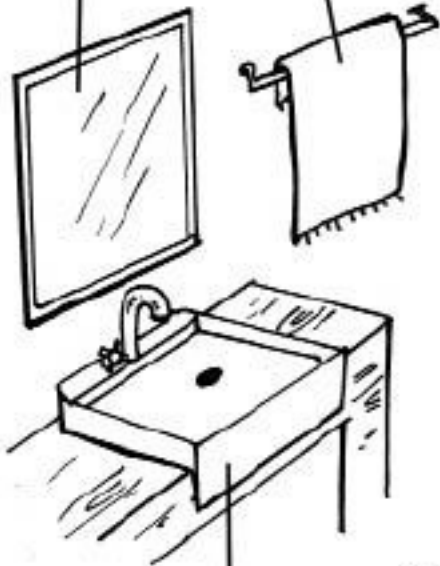

**SCOPINO DEL
GABINETTO**

CARTA IGIENICA

LAVANDINO

FRIGORIFERO
(REFRIGERADOR)

LAVAPIATTI
(LAVAPLATOS)

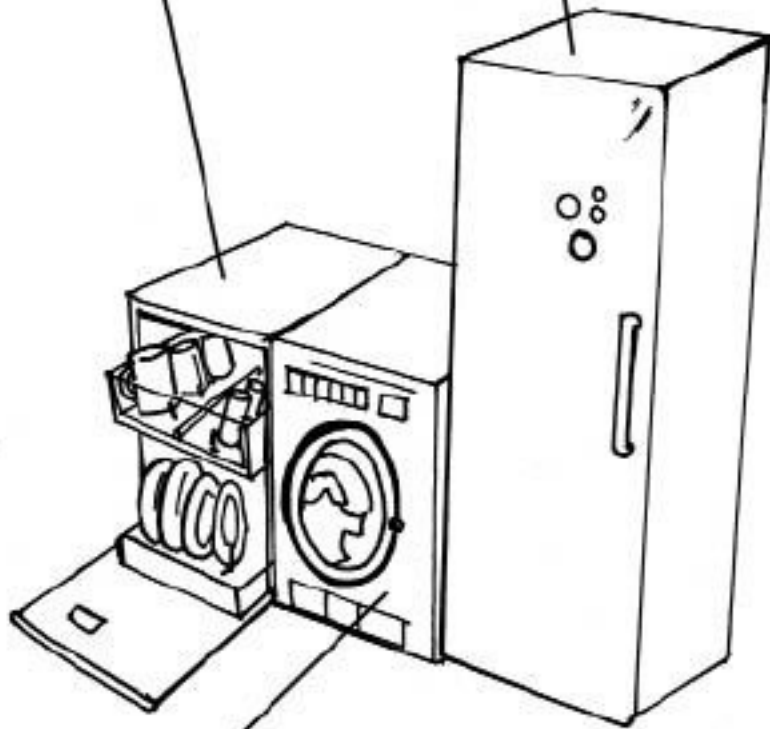

LAVATRICE
(LAVADORA)

[]
(REFRIGERADOR)

[]
(LAVAPLATOS)

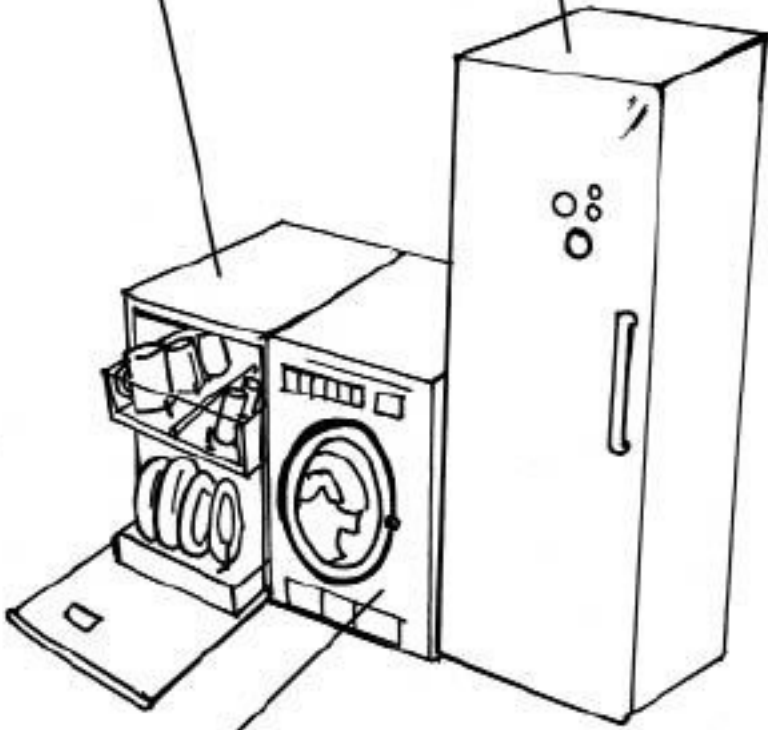

[]
(LAVADORA)

FRIGORIFERO

LAVAPIATTI

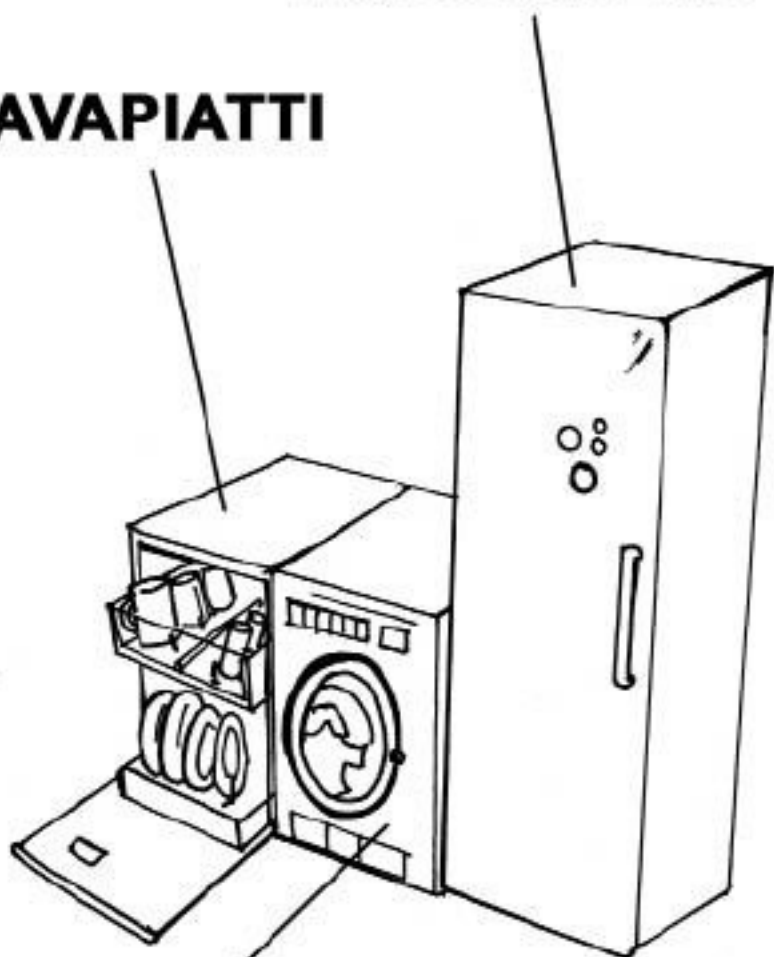

LAVATRICE

comida / mangiare

(AZÚCAR)

ZUCCHERO

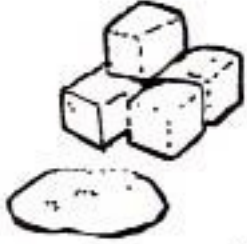

SALE
(SAL)



PEPE
(PIMIENTO)

(AZÚCAR)

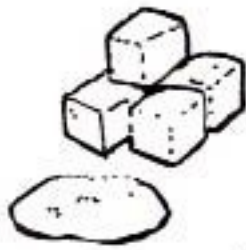

(SAL)



(PIMIENTO)

ZUCCHERO

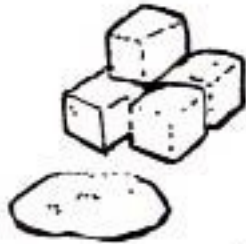

SALE



PEPE

(CUCHILLO)

COLTELLO

(TENEDOR)

FORCELLA



PANE

(PAN)

(CUCHILLO)

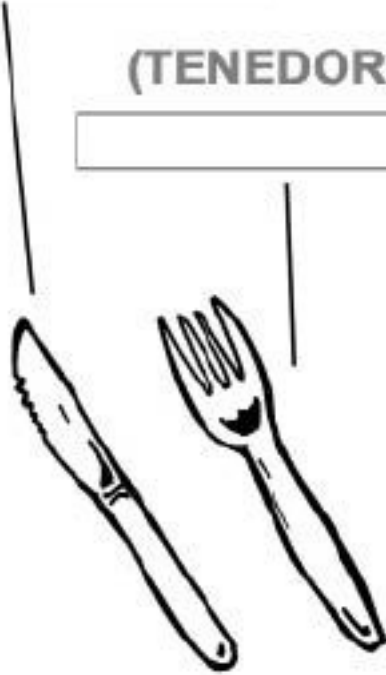

(TENEDOR)



(PAN)

COLTELLO

FORCELLA



PANE



CARNE
(CARNE)

PESCE
(PESCADO)

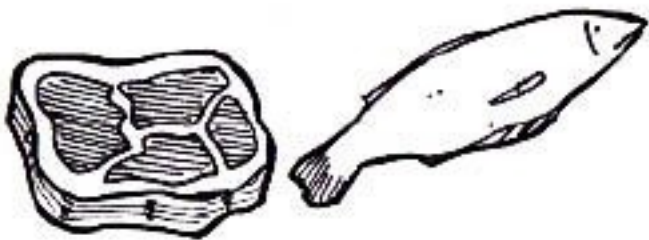

(CARNE)

(PESCADO)

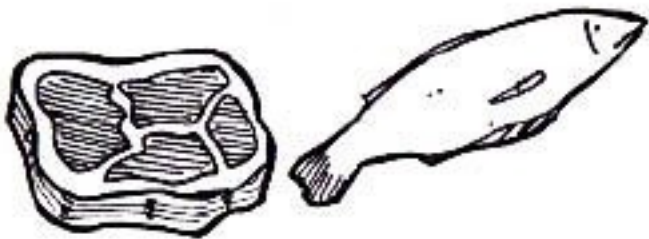

CARNE

PESCE

(LECHE)
LATTE



(QUESO)
FORMAGGIO

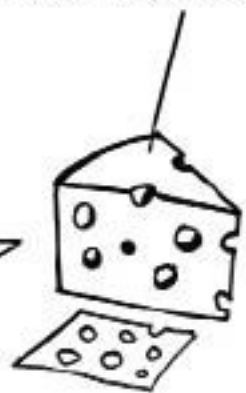

BURRO
(MANTECA)



(LECHE)



(QUESO)

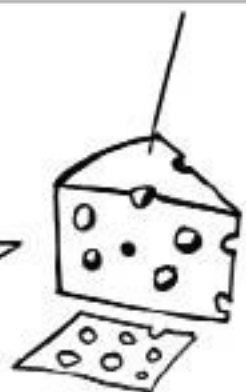

(MANTECA)



LATTE



FORMAGGIO



BURRO



(TOMATE)

POMODORO



(COHOMBRO)

COCOMERO



INSALATA

(ENSALADA)

CAROTA

(ZANAHORIA)

(TOMATE)



(COHOMBRO)

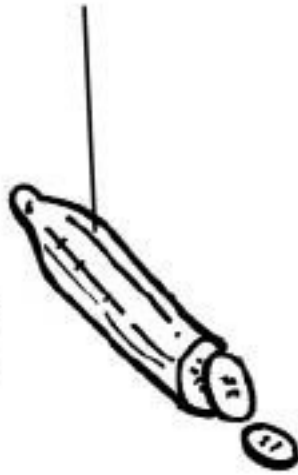

(ENSALADA)

(ZANAHORIA)

POMODORO

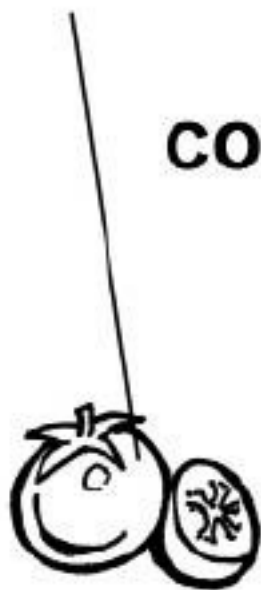

COCOMERO

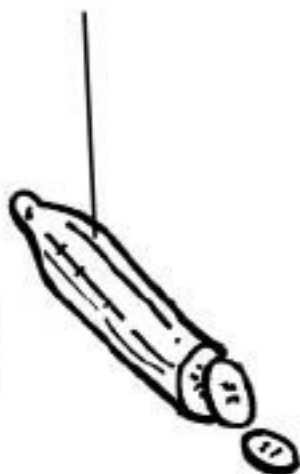

INSALATA

CAROTA

(UVAS)
GRAPPOLO D'UVA



(KIWI)
KIWI



(PIÑA)
ANANAS



COCOMERO
(SANDÍA)



MELONE
(MELÓN)



(UVAS)



(KIWI)



(PIÑA)



(SANDÍA)



(MELÓN)

GRAPPOLO D'UVA



KIWI



ANANAS



COCOMERO



MELONE

(MANZANA)

MELA



(PERA)

PERA



(NARANJA)

ARANCIA

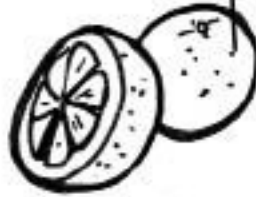

BANANA

(BANANA)



FRAGOLA

(FRESA)

(MANZANA)



(PERA)



(NARANJA)



(BANANA)



(FRESA)

MELA



PERA



ARANCIA

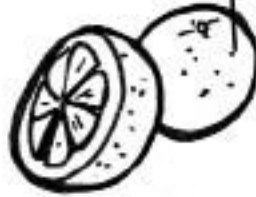

BANANA



FRAGOLA

(ESPAGUETI)

SPAGHETTI

(BASILIO)

BASILICO

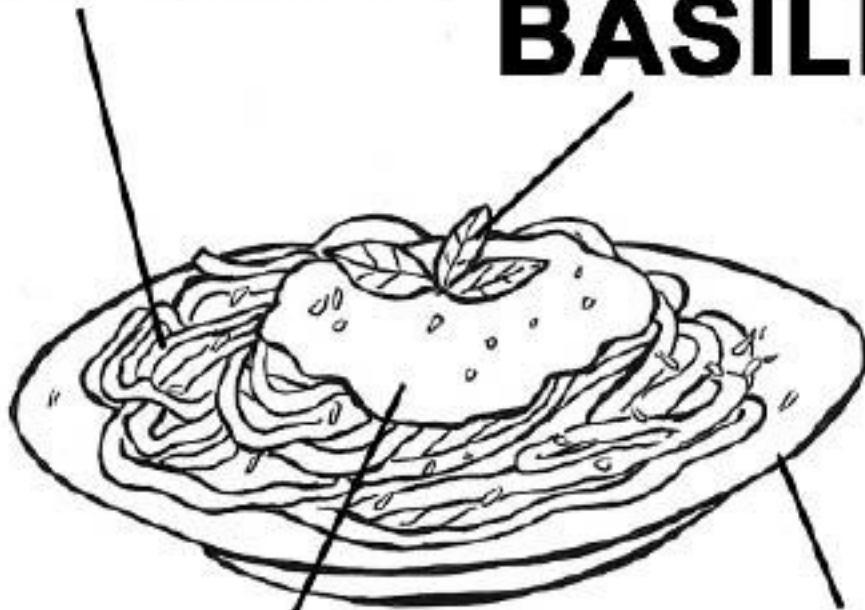

PIATTO

(PLATO)

SALSA DI POMODORO

(SALSA DE TOMATE)

(ESPAGUETI)



(BASILIO)

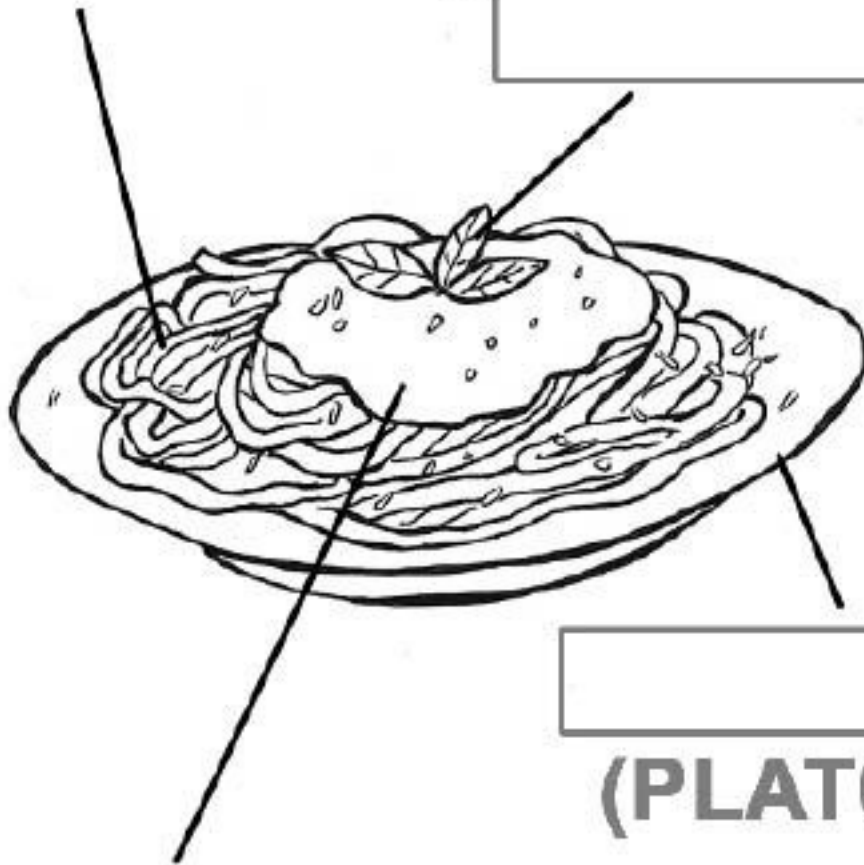

(PLATO)



(SALSA DE TOMATE)



SPAGHETTI

BASILICO

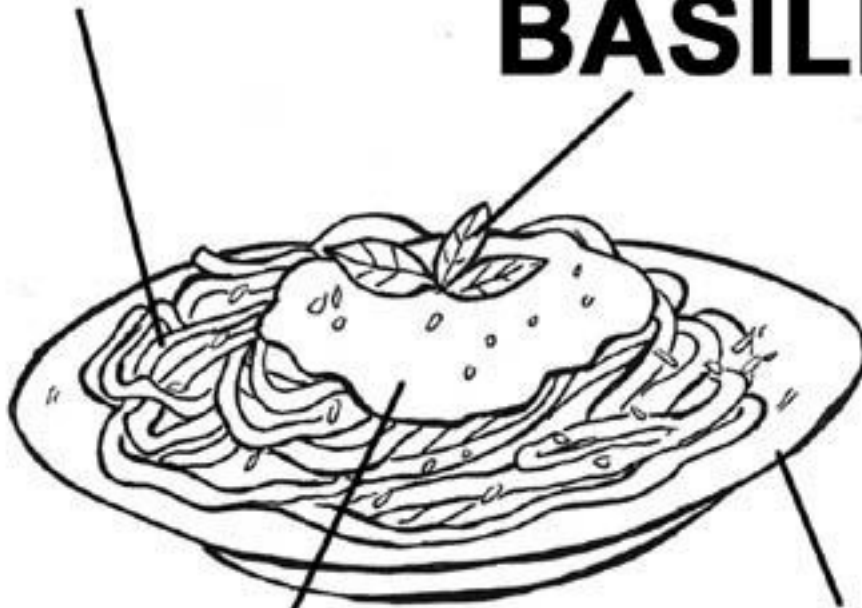

PIATTO

SALSA DI POMODORO

(PIZZA)
PIZZA

(JAMÓN)
PROSCIUTTO

(GUINDILLA)
PEPERONCINO

(OLIVA)
OLIVA



SALAME
(SALAMI)

FUNGO
(HONGO)

CIPOLLA
(CEBOLLA)

(PIZZA)

(JAMÓN)

(GUINDILLA)

(OLIVA)



(SALAMI)

(HONGO)

(CEBOLLA)

PIZZA

PROSCIUTTO

PEPERONCINO

OLIVA



SALAME

FUNGO

CIPOLLA

(TIRAMISU)
TIRAMISU



(LANGOSTA)
ASTICE

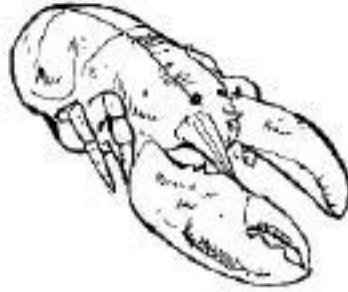

(ALMEJA)
VONGOLA



COZZA
(MEJILLÓN)



OSTRICA
(OSTRA)



INSALATA MISTA
(ENSALADA MEZCLADA)

(TIRAMISU)



(LANGOSTA)

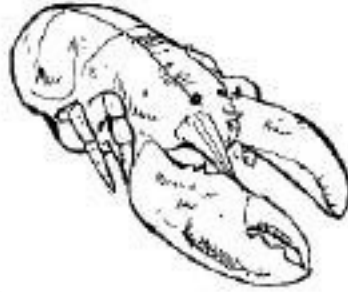

(ALMEJA)



(MEJILLÓN)



(OSTRA)



(ENSALADA MEZCLADA)

TIRAMISU



ASTICE



VONGOLA



COZZA



OSTRICA



INSALATA MISTA

(PAJILLA)

CANNUCCIA

(LIMÓN)

LIMONE



BICCHIERE
(VASO)

ACQUA
(AGUA)

(PAJILLA)



(LIMÓN)



(VASO)



(AGUA)

CANNUCCIA

LIMONE

BICCHIERE

ACQUA



(CAFÉ)
CAFFÈ



(TÈ)
TÈ (TETERA)
**BRICCO
DA TÈ**



VINO
(VINO)

BIRRA
(CERVEZA)

(CAFÉ)

(TÉ)

(TETERA)



(VINO)

(CERVEZA)

CAFFÈ



TÈ



**BRICCO
DA TÈ**



VINO

BIRRA

fuera / fuori

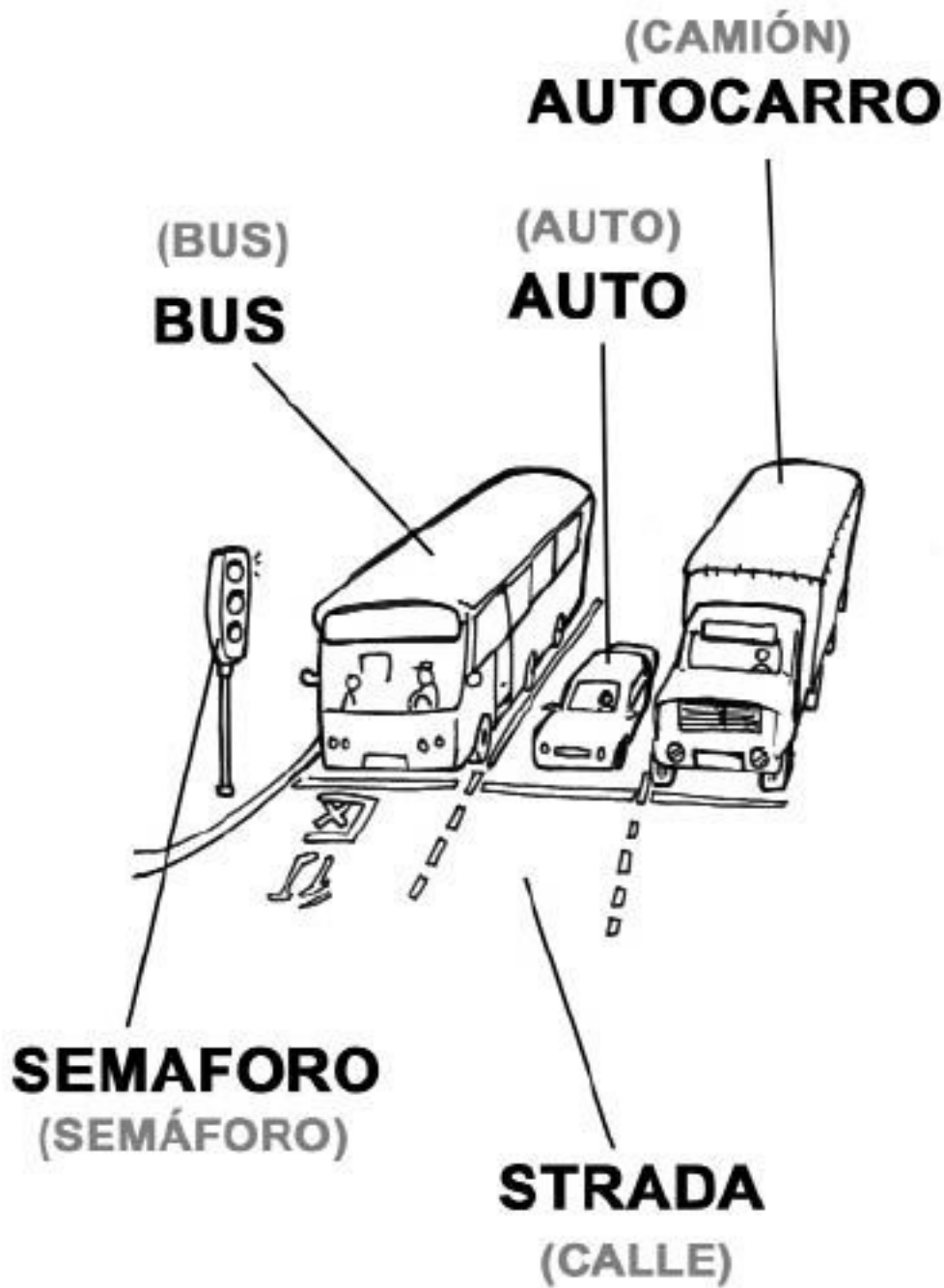

(CAMIÓN)



(BUS)



(AUTO)

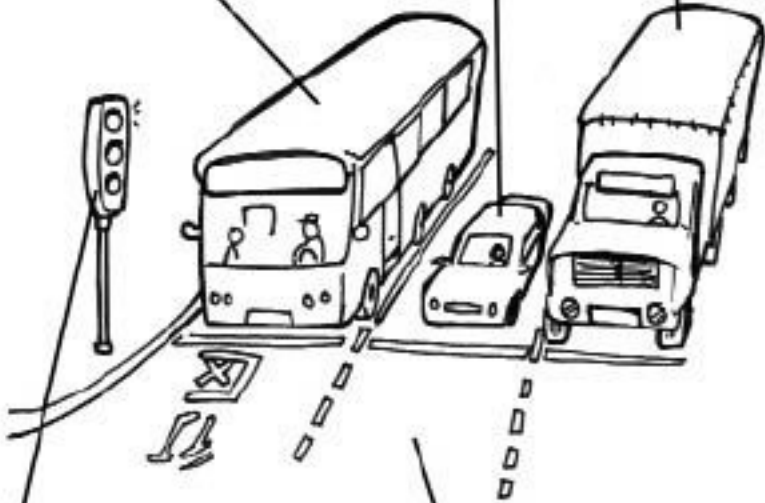

(SEMÁFORO)



(CALLE)



AUTOCARRO

BUS

AUTO

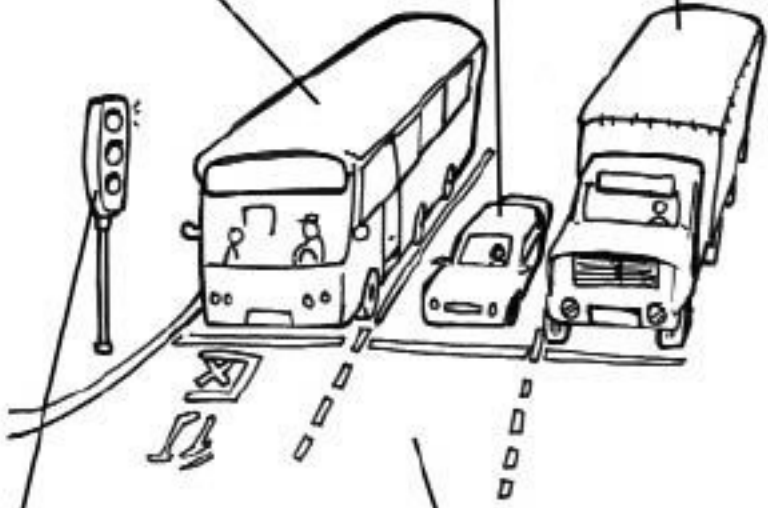

SEMAFORO

STRADA

(LLUVIA)

PIOGGIA



PARAPIOGGIA

(PARAGUAS)

(LLUVIA)



(PARAGUAS)

PIOGGIA



PARAPIOGGIA

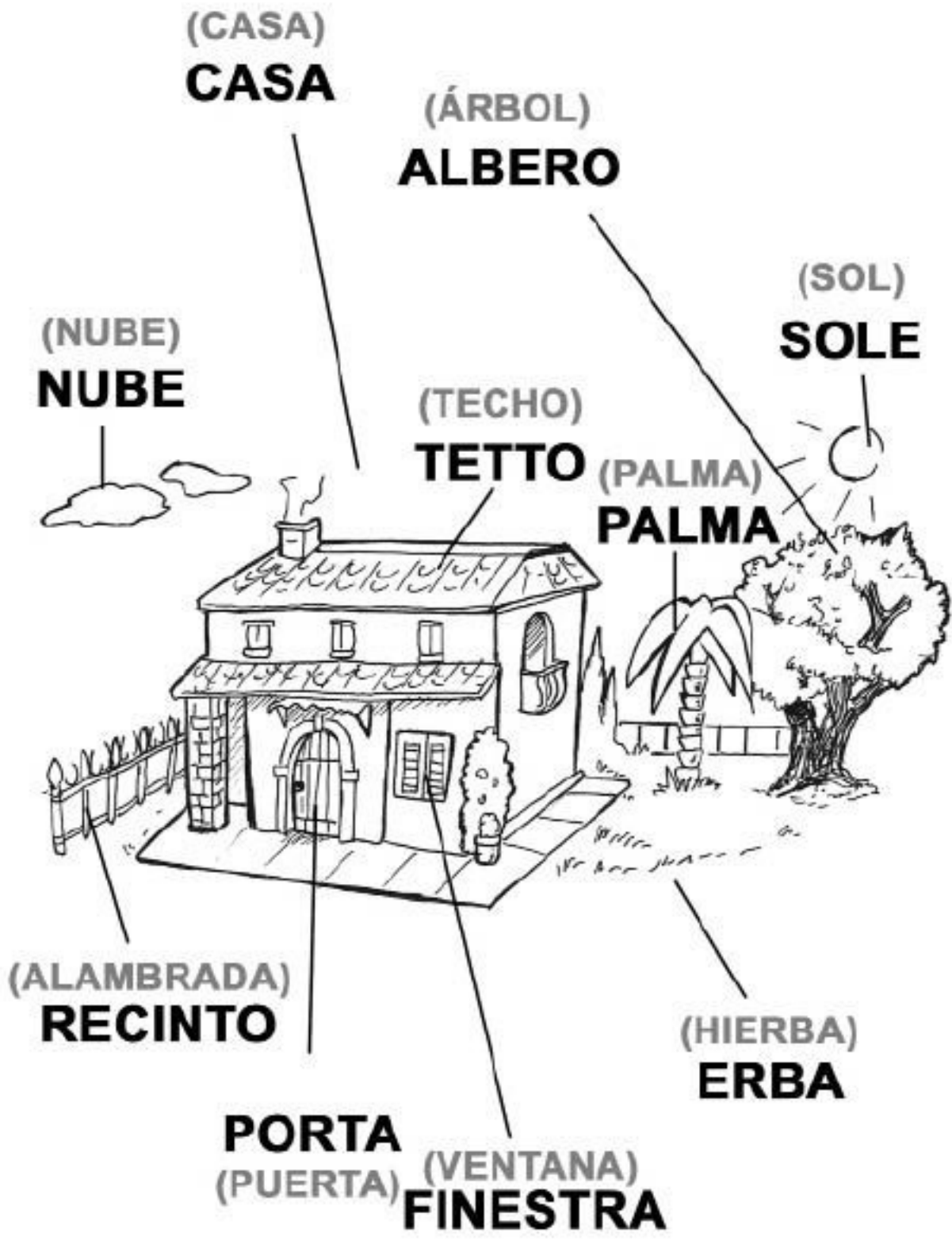

(CASA)

(ÁRBOL)

(SOL)

(NUBE)

(TECHO)

(PALMA)

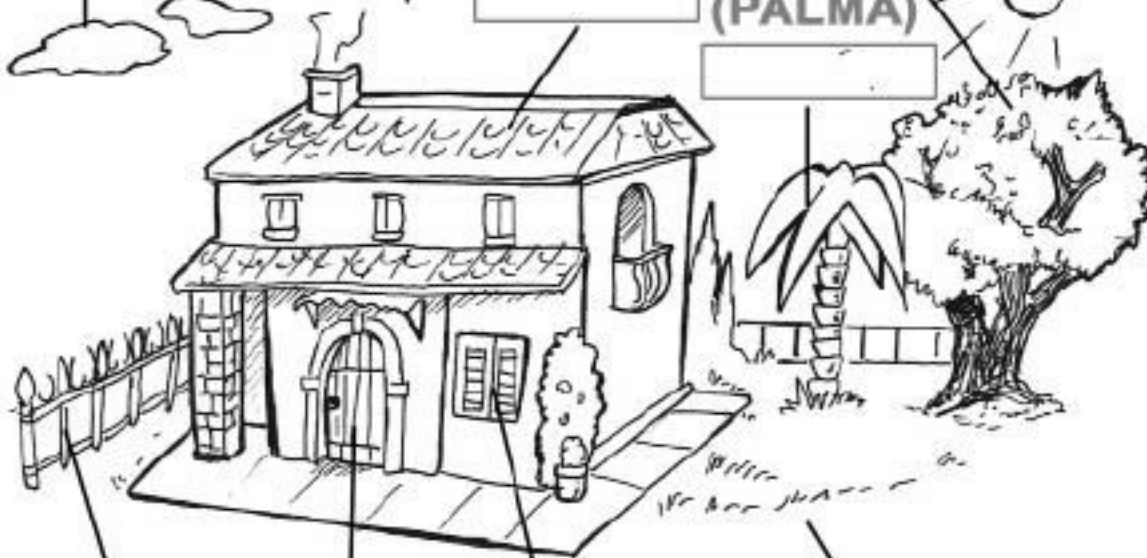

(ALAMBRADA)

(HIERBA)

(PUERTA)

(VENTANA)

(CASA)

(ÁRBOL)

(SOL)

(NUBE)

(TECHO)

(PALMA)

(ALAMBRADA)

(HIERBA)

(PUERTA)

(VENTANA)



(PUENTE)
PONTE

(GONDOLERO)
GONDOLIERE



REMO
(REMO)

GONDOLA
(GÓNDOLA)

FIUME
(RÍO)

(PUENTE)

(GONDOLERO)



(REMO)

(GÓNDOLA)

(RÍO)

PONTE

GONDOLIERE



FIUME

REMO

GONDOLA

(CHAMPÁN)
CHAMPAGNE

(ESPECTADORES)
SPETTATORI

(COPA)
COPPA

(CASCO)
CASCO

SECONDO
(2° LUGAR)

TERZO
(3ER LUGAR)

PRIMO POSTO
(1ER LUGAR)

AUTO DA CORSA
(COCHE DE CARRERAS)

PNEUMATICO
(NEUMÁTICO)

PUNTO DI ARRIVO
(FIN)

FORMULA 1
(FÓRMULA 1)

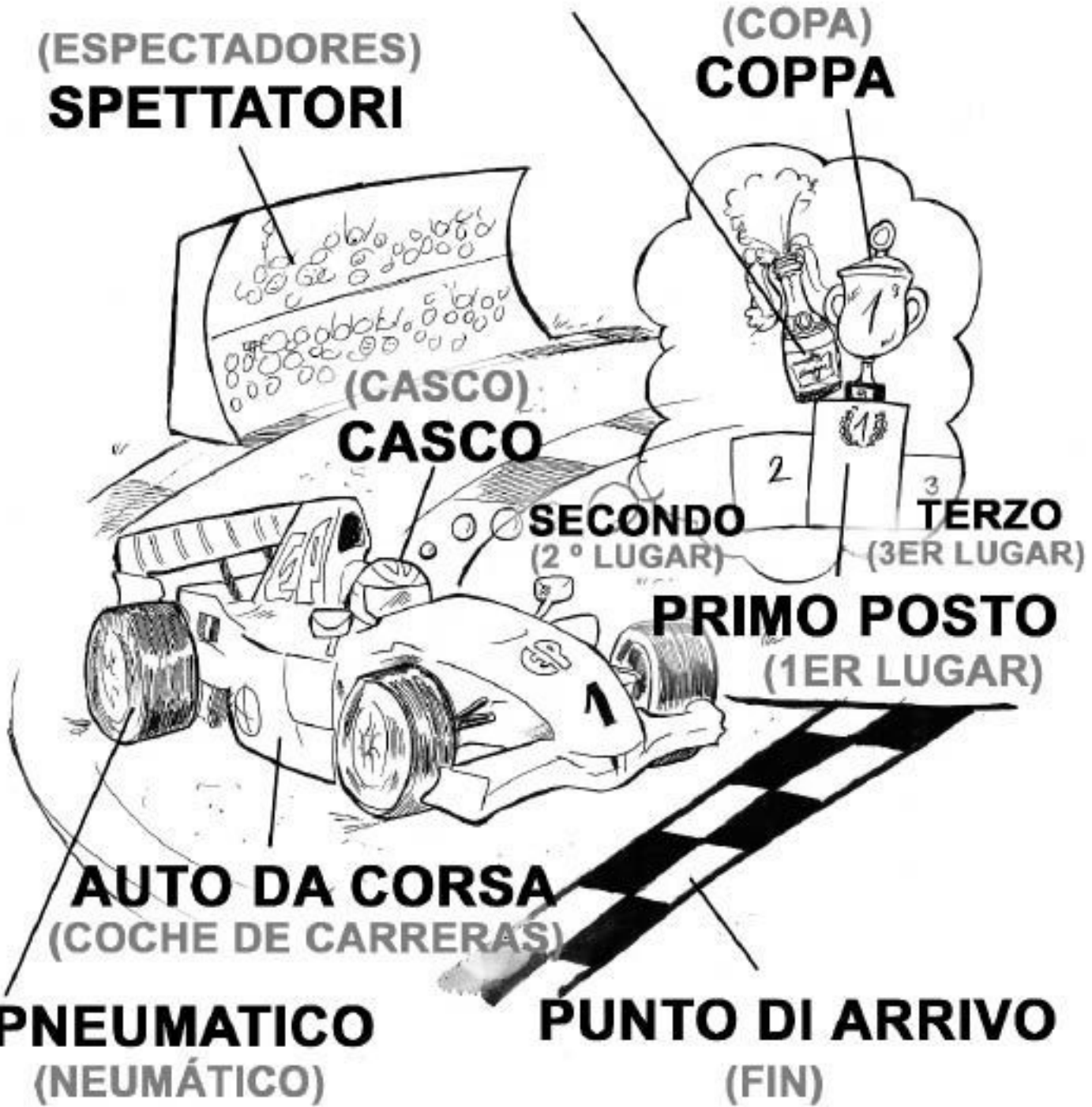

(CHAMPÁN)

(ESPECTADORES)

(COPA)

(CASCO)

(2º LUGAR)

(3ER LUGAR)

(1ER LUGAR)

(COCHE DE CARRERAS)

(NEUMÁTICO)

(FIN)

(FÓRMULA 1)

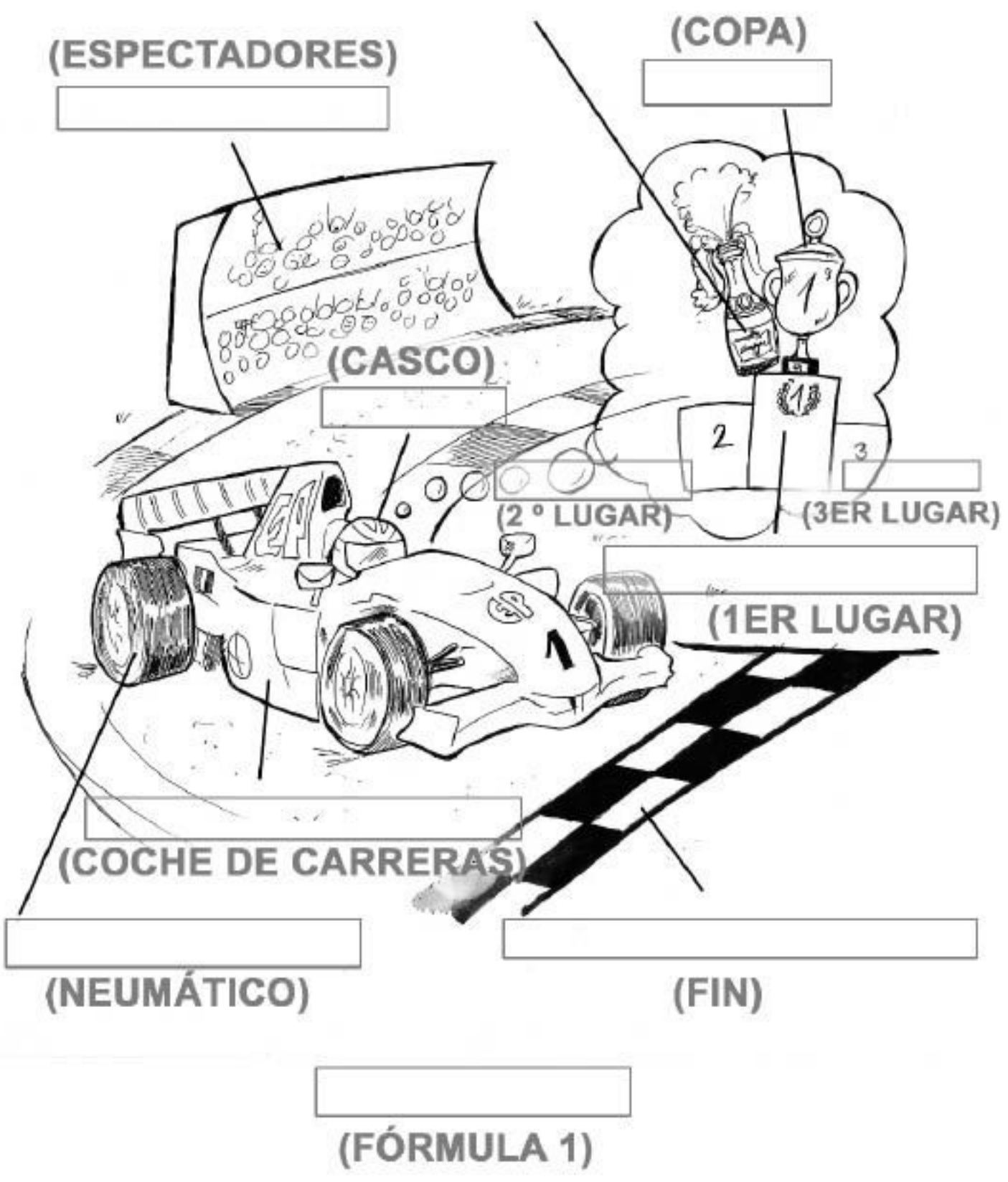

CHAMPAGNE

SPETTATORI

COPPA

CASCO

SECONDO

TERZO

PRIMO POSTO

AUTO DA CORSA

PNEUMATICO

PUNTO DI ARRIVO

FORMULA 1

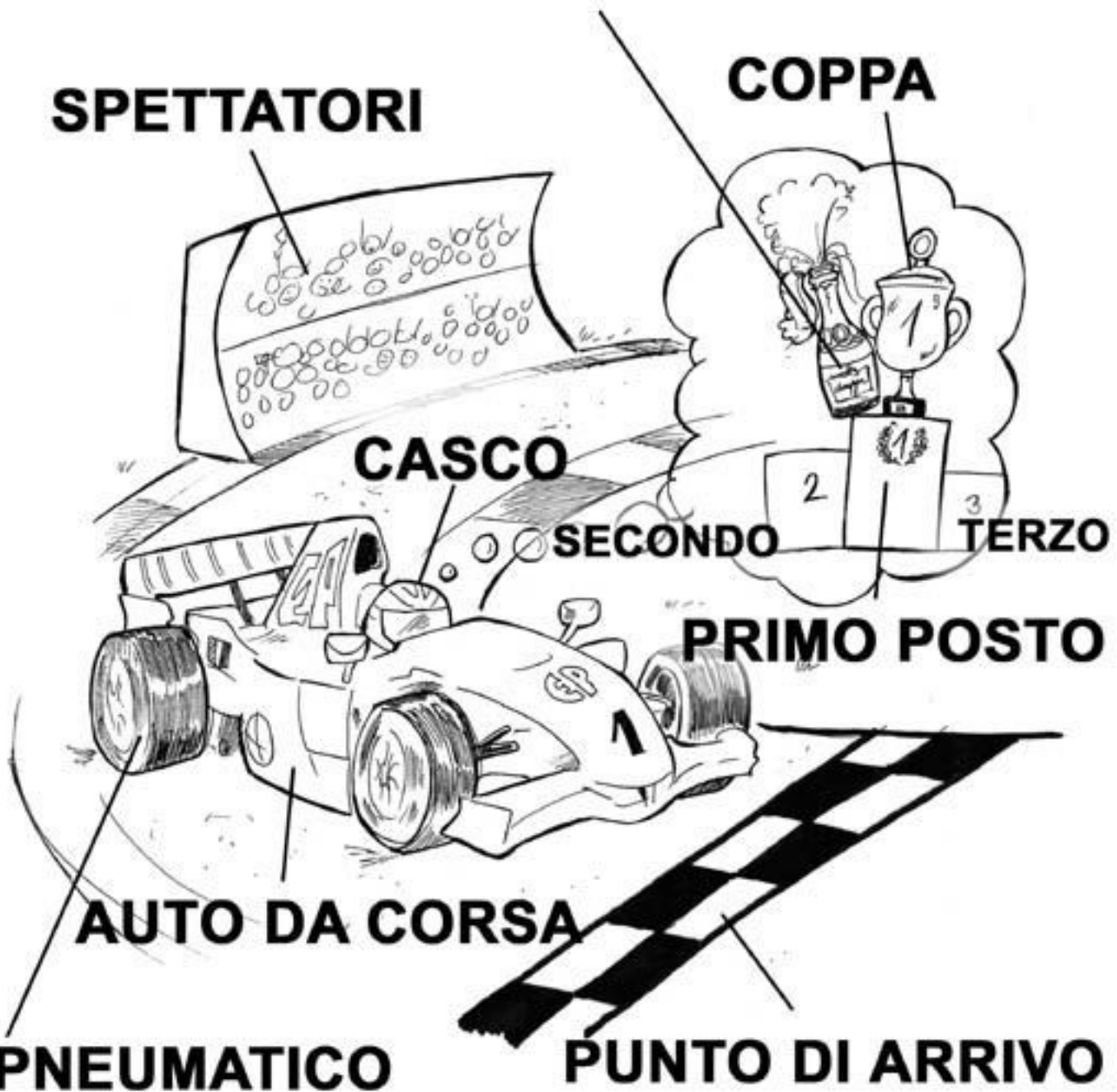

(QUITASOL)
PARASOLE

(MAR)
MARE

(OLA)
ONDA



BRANDINA
(CAMA)

LIDO
(PLAYA)

(QUITASOL)

(MAR)

(OLA)

(CAMA)

(PLAYA)

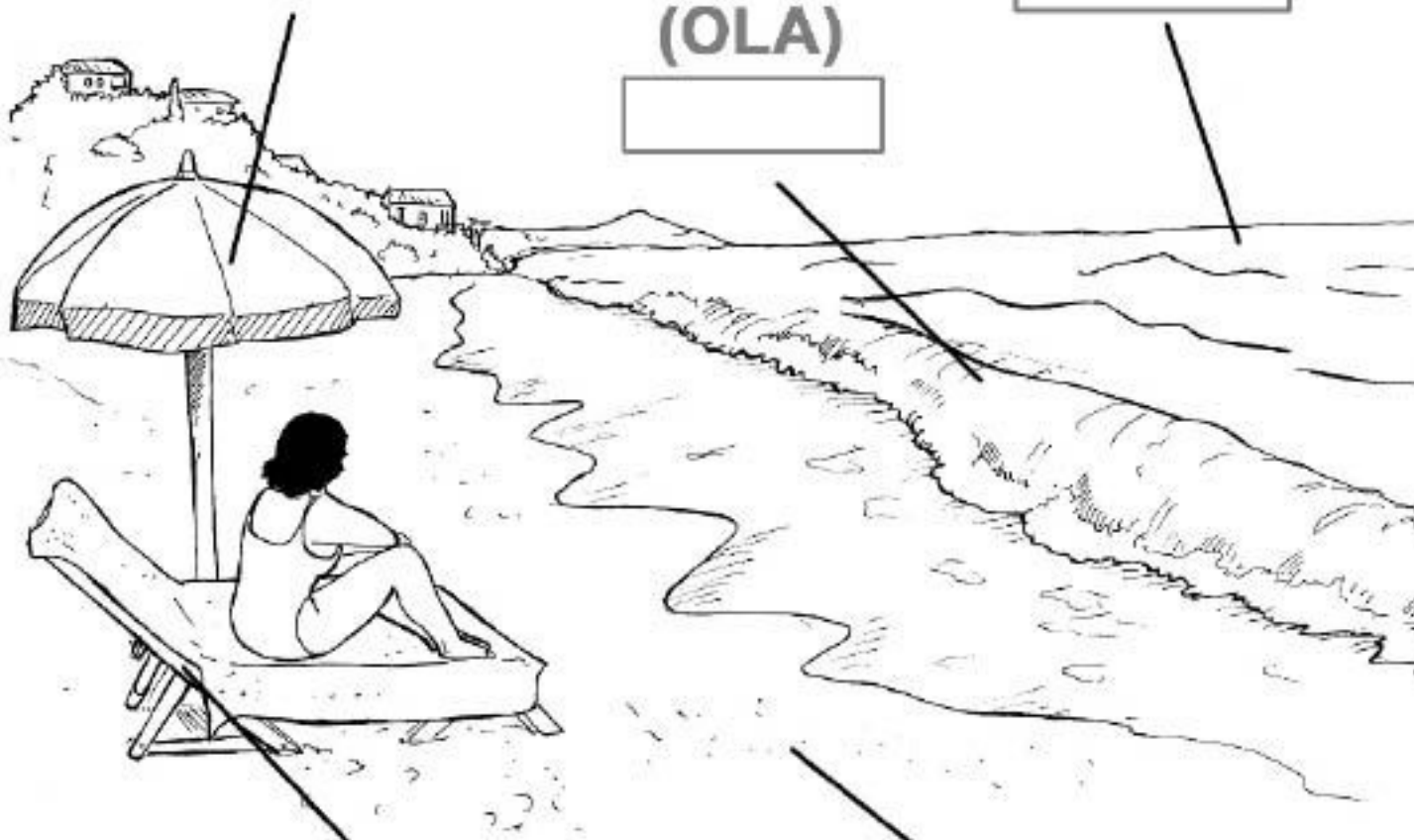

PARASOLE

MARE

ONDA

BRANDINA

LIDO

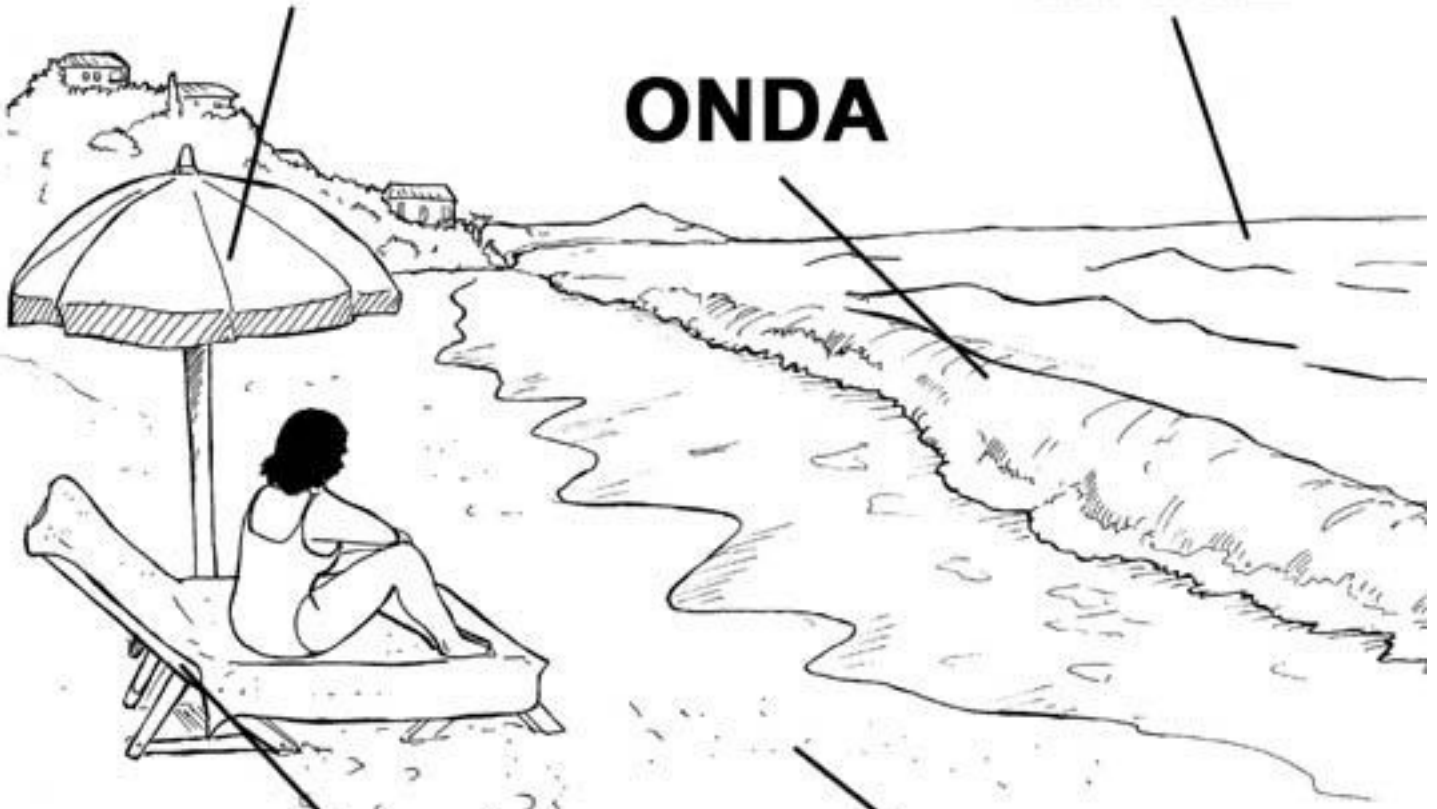

cuerpo / corpo



(CABELLO)

(CEJA)

(OJO)

(OREJA)

(NARIZ)

(BOCA)

(PANZA)

(MANO)

(PIERNA)

(PIE)

(DEDO DEL PIE)

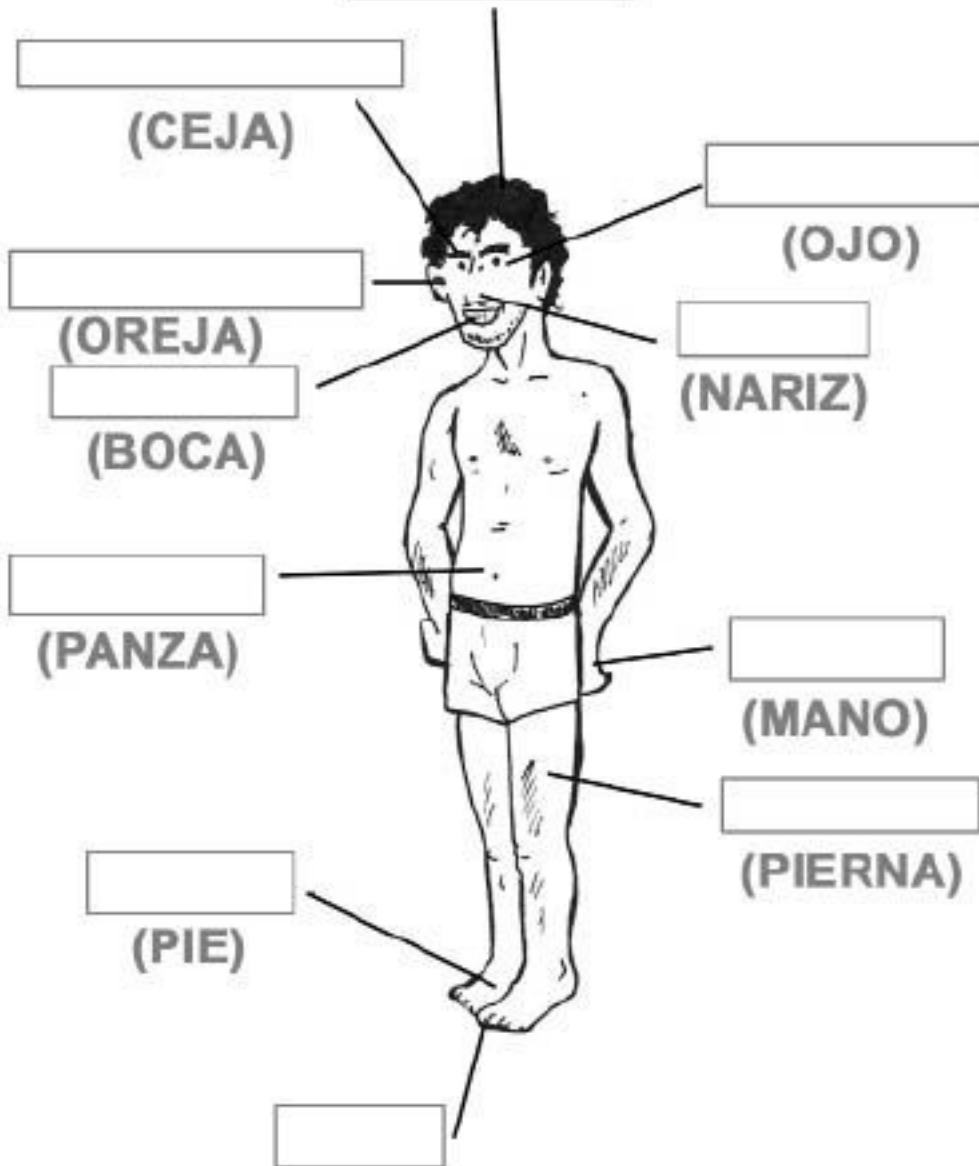



(DEDO MEÑIQUE)

MIGNOLO

(DEDO)

DITO



MANO
(MANO)

POLLICE
(PULGAR)

(DEDO MEÑIQUE)

(DEDO)



(MANO)

(PULGAR)

MIGNOLO

DITO

MANO

POLLICE



emociones / emozioni

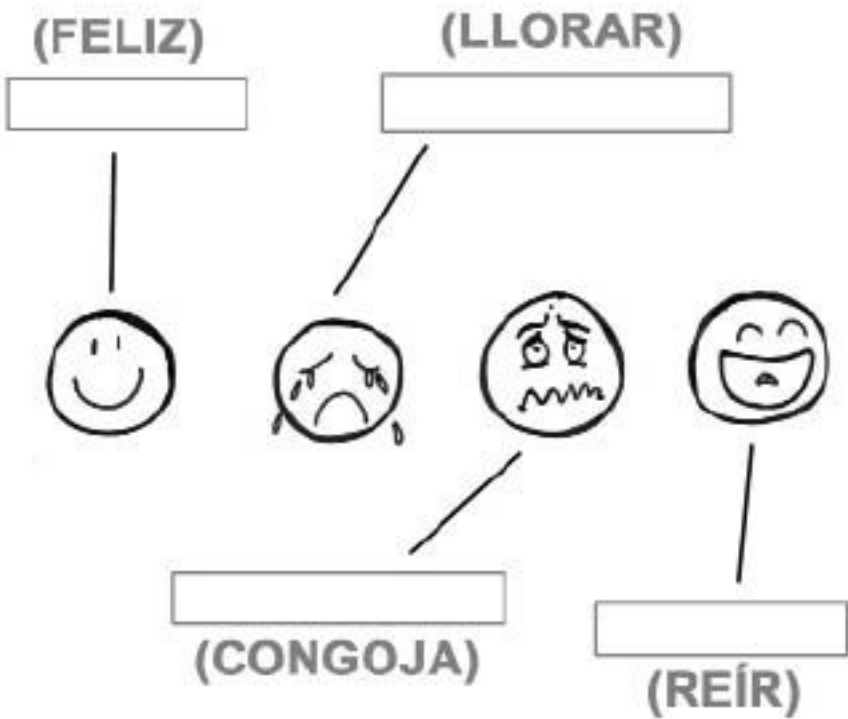
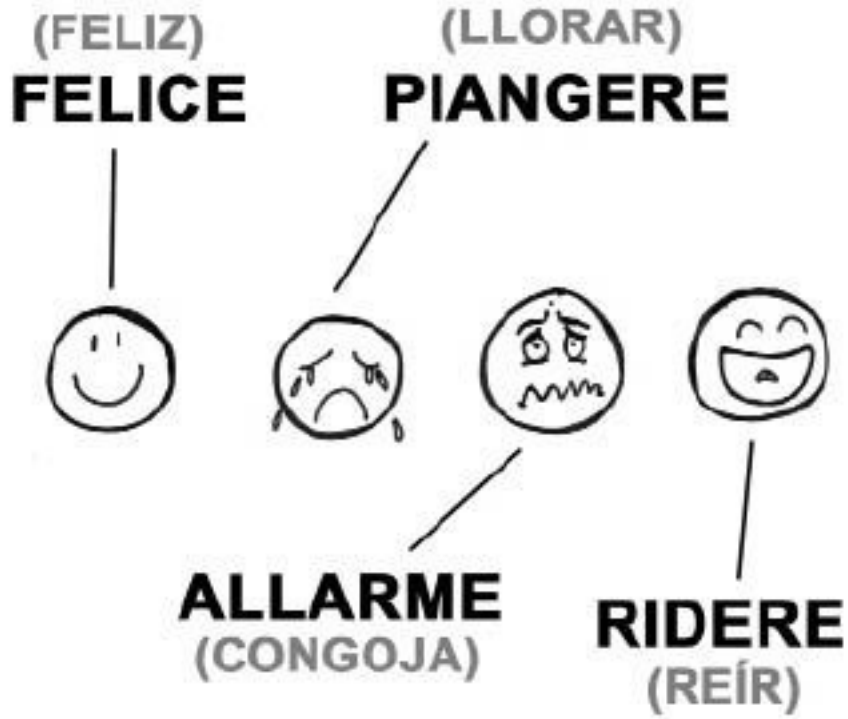

FELICE

PIANGERE



ALLARME

RIDERE

(ENOJOSO/ENOJOSA)

AGGRONDATO/AGGRONDATA

**SORPRESO/
SORPRESA**
(SORPRENDIDO/
SORPRENDIDA)

(TRISTE)

TRISTE



AMORE
(AMOR)

INNAMORATO/INNAMORATA
(ENAMORADO/ENAMORADA)

(ENOJOSO/ENOJOSA)

[Empty box]

(TRISTE)

[Empty box]

(SORPRENDIDO/
SORPRENDIDA)



[Empty box]

(AMOR)

[Empty box]

(ENAMORADO/ENAMORADA)

AGGRONDATO/AGGRONDATA

**SORPRESO/
SORPRESA**

TRISTE



AMORE

INNAMORATO/INNAMORATA

ropa / abbigliamento

(CHAQUETA)

GIACCA



(CAMISA)

CAMICIA



BOXER

(SHORTS)

CALZONCINI

(CALZONCILLOS TIPO BOXER)

(CHAQUETA)

(CAMISA)



(SHORTS)

(CALZONCILLOS TIPO BOXER)

GIACCA

CAMICIA



BOXER

CALZONCINI

(TRAJE DE BAÑO)

COSTUME DA BAGNO

(BALÓN)

PALLA

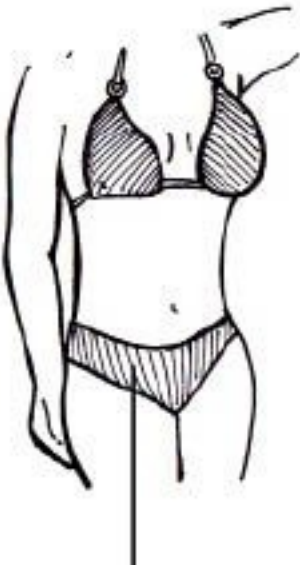
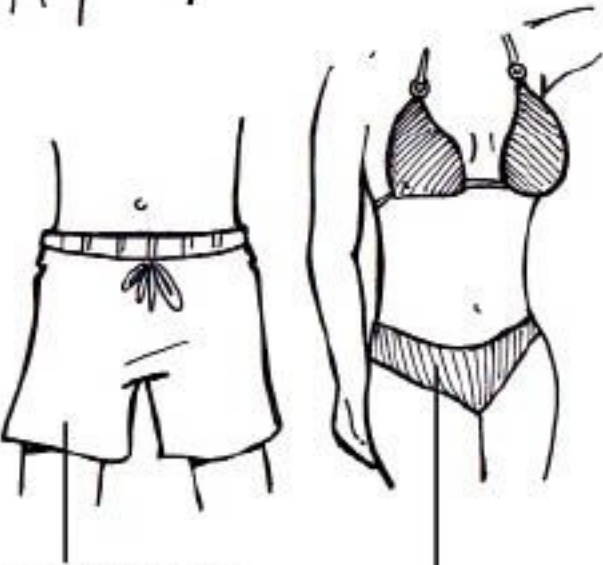

TRUNKS
(TRONCOS)

BIKINI
(BIKINI)

(TRAJE DE BAÑO)

(BALÓN)

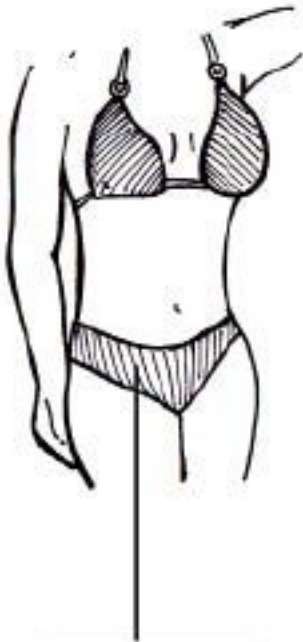

(TRONCOS)

(BIKINI)

COSTUME DA BAGNO



PALLA

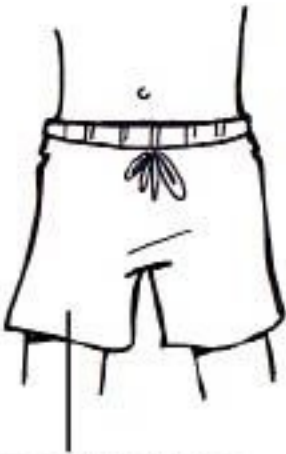

TRUNKS



BIKINI

(VAQUEROS)

JEANS



(FALDA)

GONNA



CALZA
(CALCETÍN)



SANDALO
(SANDALIA)

(VAQUEROS)



(FALDA)



(SANDALIA)



(CALCETÍN)

JEANS



GONNA



SANDALO

CALZA

(BAMBA)

SCARPA DI GINNASTICA

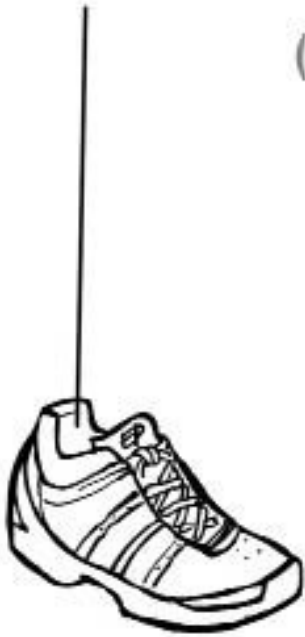

(CAMISETA)

T-SHIRT



CINGHIA

(CINTURÓN)

STIVALE

(BOTA)

(BAMBA)

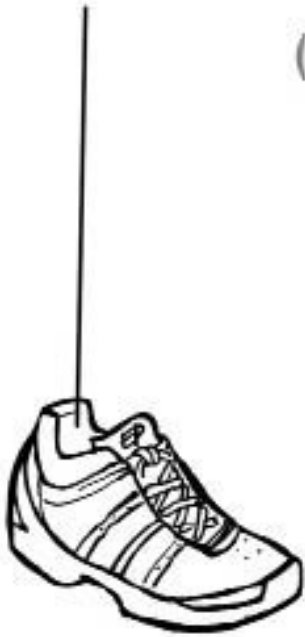

(CAMISETA)



(CINTURÓN)

(BOTA)

SCARPA DI GINNASTICA

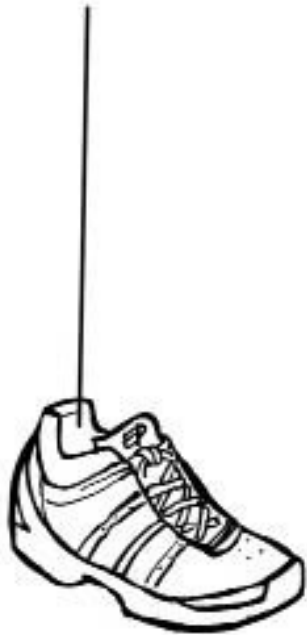

T-SHIRT



CINGHIA

STIVALE

(VESTIDO)
VESTITO

(CALZONCILLO)
MUTANDINA

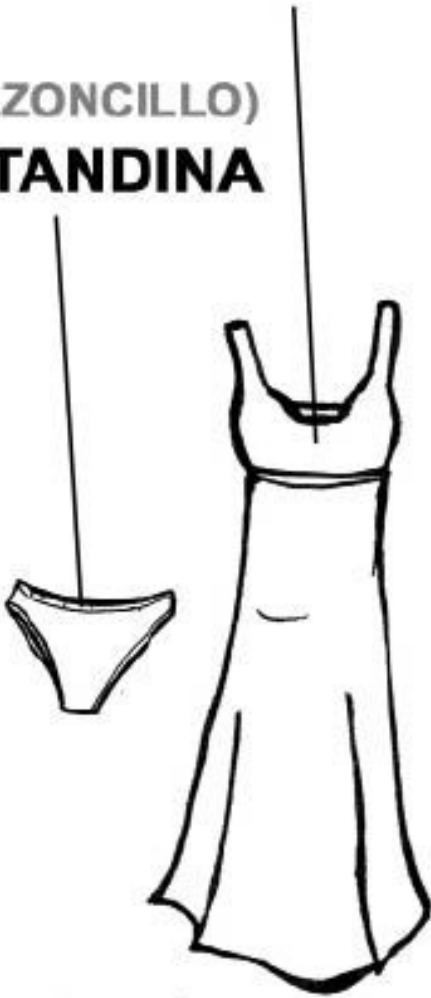

**SCARPA CON
TACCO A
SPILLO**

(ZAPATO DE
TACÓN ALTO)

BORSA
(BOLSO DE MANO)

(VESTIDO)

(CALZONCILLO)



(ZAPATO DE TACÓN ALTO)

(BOLSO DE MANO)

VESTITO

MUTANDINA



**SCARPA CON
TACCO A
SPILLO**

BORSA

(MÓVIL)

TELEFONINO

(RELOJ DE PULSERA)

**OROLOGIO
DA POLSO**



VALIGIA

(MALETA)

SACCO DA MONTAGNA

(MOCHILA)

(MÓVIL)

[Empty box]

(RELOJ DE PULSERA)

[Empty box]



[Empty box]

(MALETA)

[Empty box]

(MOCHILA)

TELEFONINO



**OROLOGIO
DA POLSO**



VALIGIA

SACCO DA MONTAGNA

(BOINA)
BERRETTO



(GUANTE)
GUANTO



CAPPELLO
(SOMBRERO)

SCIARPA
(BUFANDA)

(BOINA)

(GUANTE)



(SOMBRERO)

(BUFANDA)

BERRETTO

GUANTO



CAPPELLO

SCIARPA

animales / gli animali

RATA
RATTO



BUEY
MANZO



TIGRE
TIGRE

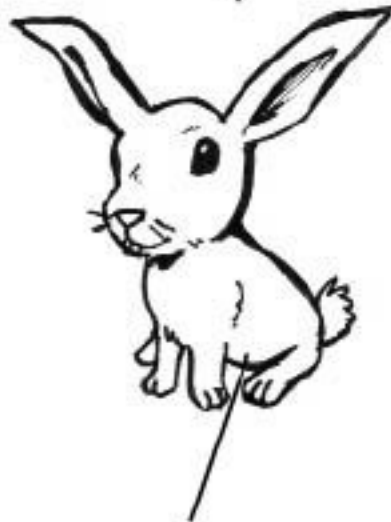

LEPRE
LIEBRE

RATA



BUEY

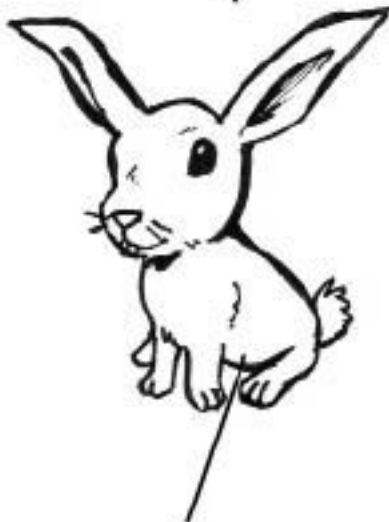

TIGRE

LIEBRE

RATTO



MANZO

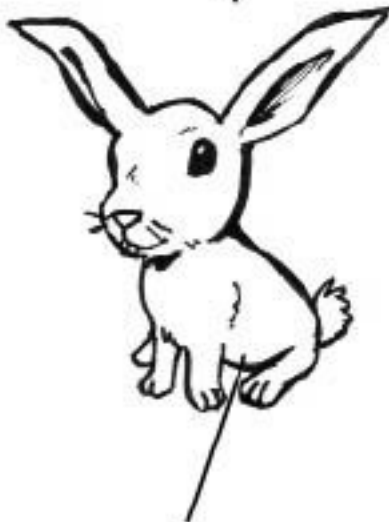

TIGRE

LEPRE

DRAGÓN
DRAGO



SERPIENTE
SERPE



CAVALLO
CABELLO



CAPRA
CABRA

DRAGÓN



SERPIENTE

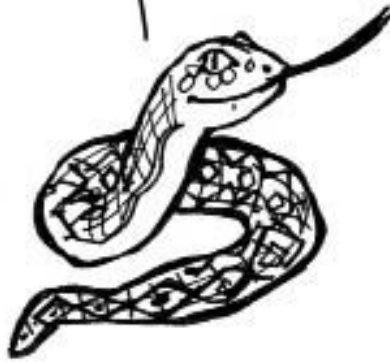

CABELLO



CABRA

DRAGO



SERPE



CAVALLO



CAPRA

MONO
SCIMMIA

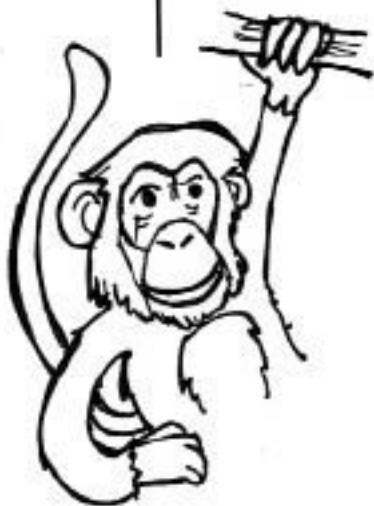

GALLO
GALLO

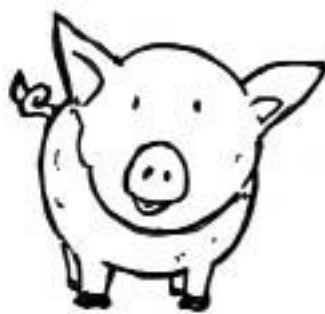
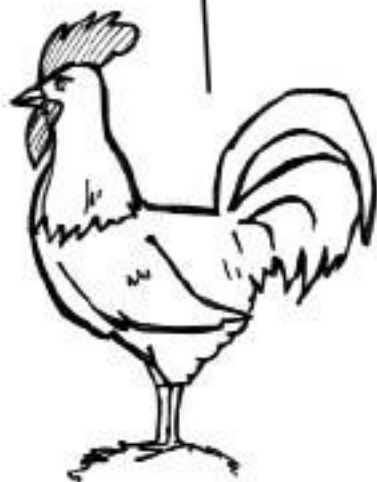

PORCO
CERDO

CANE
PERRO

MONO



GALLO

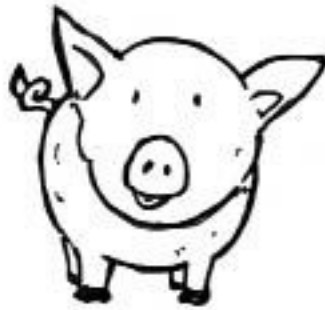

CERDO

PERRO

SCIMMIA



GALLO

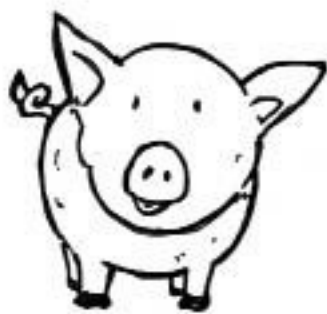
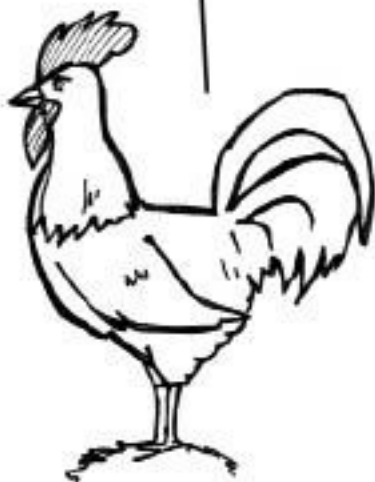

PORCO

CANE



GATTO
(GATO)



UCCELLO
(PÁJARO)



(GATO)



(PÁJARO)



GATTO



UCCELLO

familia / famiglia

(MUJER)
DONNA



(HOMBRE)
UOMO



(HIJA)
FIGLIA



MADRE
(MADRE)

PADRE
(PADRE)

FIGLIO
(HIJO)

(MUJER)



(HOMBRE)



(HIJA)



(MADRE)

(PADRE)

(HIJO)

DONNA



UOMO



FIGLIA



MADRE

PADRE

FIGLIO

estaciones del año / stagione dell'anno

(PRIMAVERA)

PRIMAVERA



(VERANO)

ESTATE

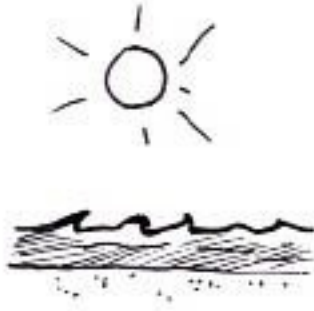

AUTUNNO

(OTOÑO)



INVERNO

(INVIERNO)

(PRIMAVERA)



(VERANO)

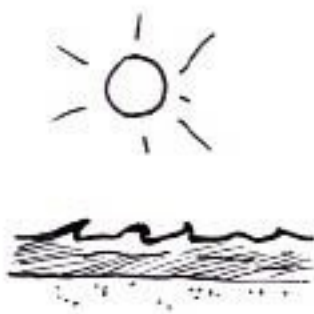

(OTOÑO)

(INVIERNO)

PRIMAVERA

ESTATE

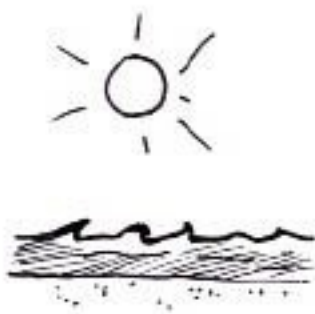

AUTUNNO

INVERNO

números / i numeri



(DOCE)

(UNO)

(ONCE)

(DOS)

(DIEZ)

(TRES)

(NUEVE)

(CUATRO)

(OCHO)

(SIETE)

(CINCO)

(SEIS)





extras

**(CRUZAR)
CROCE**

**(PINTURA)
DIPINTO**



**(CEPILLE)
PENNELLO**



**PAPA
(PAPA)**

**PITTORE
(PINTOR)**

**CAVALLETTO
(CABALLETE)**

(CRUZAR)

(PINTURA)

(CEPILLE)



(PAPA)



(PINTOR)

(CABALLETE)

CROCE

DIPINTO



PENNELLO



PAPA

PITTORE

CAVALLETTO

(METRALLETA)

PISTOLA MITRAGLIATRICE

(GÁNGSTER)
MAFIOSO

(ESTRELLA)
STELLA

(LUNA)
LUNA

(CIGARRO)
SIGARO



CUOCO
(COCINERO)

CEMENTO
(CEMENTO)

MONETA
(DINERO)

CRAVATTA
(CORBATA)

ABITO DA UOMO
(TRAJE)

(METRALLETA)

[Empty box]

(GÁNGSTER)

[Empty box]

(ESTRELLA)

[Empty box]

(LUNA)

[Empty box]

(CIGARRO)

[Empty box]



(COCINERO)

(CEMENTO)

(DINERO)

(CORBATA)

(TRAJE)

PISTOLA MITRAGLIATRICE

MAFIOSO

STELLA

LUNA

SIGARO

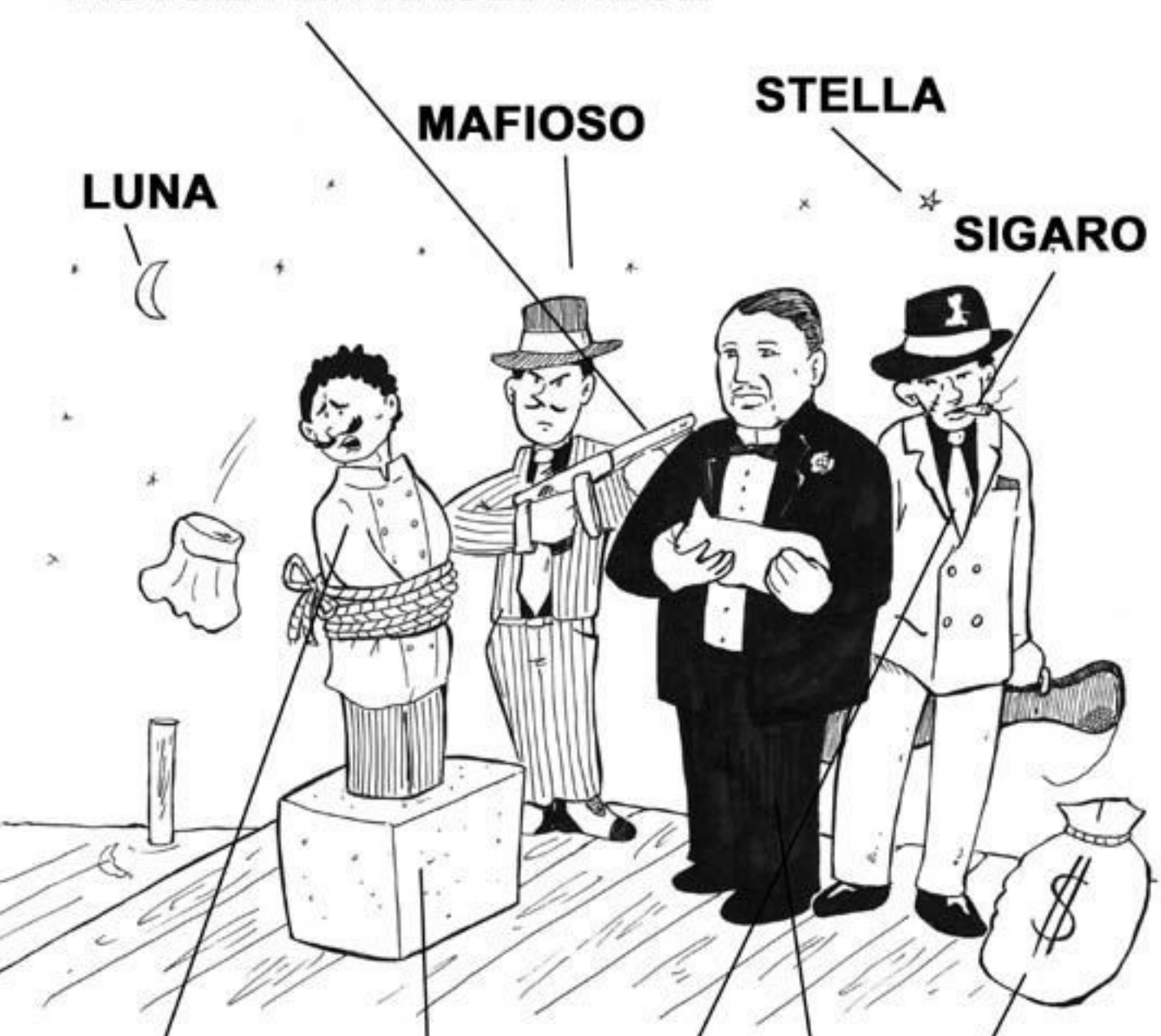

CUOCO

CEMENTO

MONETA

CRAVATTA

ABITO DA UOMO

diccionario

español - italiano

español	italiano
.. reloj	.. orologio
1er Lugar	primo posto
2 º Lugar	secondo posto
3er lugar	terzo posto
adhesivo	adesivo
agua	acqua
alambrada	recinto
almeja	vongola
almohada	cuscinò
amor	amore
aparato de música	stereo
árbol	albero
auto	auto
azúcar	zucchero
balón	palla
bamba	scarpa di ginnastica
banana	banana
base	presa
basilio	basilico
bikini	bikini
boca	bocca
boina	berretto
bolso de mano	borsa
bota	stivale

botella	bottiglia
brazo	braccio
buey	manzo
bufanda	sciarpa
buró	scrivania
bus	bus
caballete	cavalletto
cabello	capelli
cabello	cavallo
cable	cavo
cabra	capra
café	caffè
cajón	cassetto
calcetín	calza
calculadora	calcolatrice
caldero	pentola
calle	strada
calma	letto
calzoncillo	mutandina
calzoncillos tipo boxer	boxer
cama	brandina
camión	autocarro
camisa	camicia
camiseta	t-shirt
campana de extracción de gases	cappa

carne	carne
carta	lettera
casa	casa
casco	casco
cazuela	padella
cebolla	cipolla
cedé	cd
ceja	sopracciglio
cemento	cemento
cepille	pennello
cepillo	spazzola per capelli
cepillo de dientes	spazzolino da denti
cerdo	porco
cerveza	birra
champán	champagne
chaqueta	giacca
chimenea	camino
cigarro	sigaro
cinco	cinque
cinturón	cinghia
coche de carreras	auto da corsa
cocinero	cuoco
cohombro	cocomero
colcha	coperta da letto
colchón	materasso

computador	computer
congoja	allarme
copa	coppa
corbata	cravatta
cortina	cortina
cruzar	croce
cuatro	quattro
cuchara	cucchiaio
cuchillo	coltello
dedo del pie	dito
dedo meñique	mignolo
diente	dente
diez	dieci
dinero	moneta
doce	dodici
dos	due
dragón	drago
enamorado/enamorada	innamorato, innamorata
enojoso/enojosa	aggrondato/aggrondata
ensalada	insalata
ensalada mezclada	insalata mista
escobilla de retrete	scopino del gabinetto
espagueti	spaghetti
espectadores	spettatori
espejo	specchio

estampilla	timbro
estrella	stella
estufa	forno
falda	gonna
feliz	felice
fin	punto di arrivo
flor	fiore
florero	vaso
fórmula 1	formula 1
fresa	fragola
gafas	occhiali
gallo	gallo
gángster	mafioso
gato	gatto
góndola	gondola
gondolero	gondoliere
grifo	rubinetto
guante	guanto
guindilla	peperoncino
hierba	erba
hija	figlia
hijo	figlio
hombre	uomo
hongo	fungo
horno	fornello

invierno	inverno
jamón	prosciutto
kiwi	kiwi
lámpara	lampada
langosta	astice
lapicero	penna biro
lápiz	matita
lavabo	lavandino
lavadora	lavatrice
lavaplatos	lavapiatti
leche	latte
libro	libro
liebre	lepre
limón	limone
llorar	piangere
lluvia	pioggia
luna	luna
madre	madre
maleta	valigia
mano	mano
manteca	burro
manzana	mela
mar	mare
mejillón	cozza
melón	melone

memoria USB	chiave USB
mesa auxiliar	tavolino
metralleta	pistola mitragliatrice
microonda	microonda
mochila	sacco da montagna
mono	scimmia
móvil	telefonino
mujer	donna
naranja	arancia
nariz	naso
neumático	pneumatico
niño	bambino
nube	nube
nueve	nove
ocho	otto
ojo	occhio
ola	onda
oliva	oliva
once	undici
oreja	orecchio
ostra	ostrica
otoño	autunno
padre	padre
pájaro	uccello
pajilla	cannuccia

palma	palma
pan	pane
pantalla	schermo
panza	pancia
papa	papa
papel a cuadros	carta millimetrata
papel higiénico	carta igienica
papelera	cestino
papeleta	carta
paraguas	parapioggia
parlante	altoparlante
pasta de dientes	dentifricio
pera	pera
perro	cane
pescado	pesce
pie	piede
pierna	gamba
pimiento	pepe
piña	ananas
pintor	pittore
pintura	dipinto
pizza	pizza
planta	pianta
plato	piatto
playa	lido

primavera	primavera
punte	ponte
puerta	porta
pulgar	pollice
queso	formaggio
quitasol	parasole
rata	ratto
ratón del ordenador	mouse
refrigerador	frigorifero
reír	ridere
reloj de pulsera	orologio da polso
remo	remo
río	fiume
rosa	rosa
sal	sale
salami	salame
salsa de tomate	salsa di pomodoro
sandalia	sandalo
sandía	cocomero
seis	sei
semáforo	semaforo
serpiente	serpe
servicio	toilette
servilleta	tovagliolo
shorts	calzoncini

siete	sette
sillón	poltrona
sofá	sofà
sol	sole
sombrero	cappello
sopa	zuppa
sorprendido/sorprendida	sorpreso/sorpresa
té	tè
techo	tetto
teclado	tastiera
telecomando	telecomando
telefónico	telefono
televisión	televisore
tenedor	forcella
tetera	bricco da tè
tigre	tigre
tijera	forbice
Tiramisu	tiramisu
toalla	asciugamano
tomate	pomodoro
traje	abito da uomo
traje de baño	costume da bagno
tres	tre
triste	triste
trancos	trunks
uno	uno
uvas	grappolo d'uva
vaqueros	jeans
vaso	bicchiere
vela	candela
ventana	finestra
verano	estate
vestido	vestito
vino	vino
zanahoria	carota
zapato	scarpa
zapato de tacón alto	scarpa con tacco a spillo

italiano - español

italiano	español
.. orologio	.. reloj
abito da uomo	traje
acqua	agua
adesivo	adhesivo
aggrondato/aggrondata	enojoso/enojosa
albero	árbol
allarme	congoja
altoparlante	parlante
amore	amor
ananas	piña
arancia	naranja
asciugamano	toalla
astice	langosta
auto	auto
auto da corsa	coche de carreras
autocarro	camión
autunno	otoño
bambino	niño
banana	banana
basilico	basilio
berretto	boina
bicchiere	vaso
bikini	bikini
birra	cerveza

bocca	boca
borsa	bolso de mano
bottiglia	botella
boxer	calzoncillos tipo boxer
braccio	brazo
brandina	cama
bricco da tè	tetera
burro	manteca
bus	bus
caffè	café
calcolatrice	calculadora
calza	calcetín
calzoncini	shorts
camicia	camisa
camino	chimenea
candela	vela
cane	perro
cannuccia	pajilla
capelli	cabello
cappa	campana de extracción de gases
cappello	sombrero
capra	cabra
carne	carne
carota	zanahoria
carta	papeleta

carta igienica	papel higiénico
carta millimetrata	papel a cuadros
casa	casa
casco	casco
cassetto	cajón
cavalletto	caballete
cavallo	cabello
cavo	cable
cd	cedé
cemento	cemento
cestino	papelera
champagne	champán
chiave USB	memoria USB
cinghia	cinturón
cinque	cinco
cipolla	cebolla
cocomero	sandía
cocomero	cohombro
coltello	cuchillo
computer	computador
coperta da letto	colcha
coppa	copa
cortina	cortina
costume da bagno	traje de baño
cozza	mejillón

cravatta	corbata
croce	cruzar
cucchiaino	cuchara
cuoco	cocinero
cuscinio	almohada
dente	diente
dentifricio	pasta de dientes
dieci	diez
dipinto	pintura
dito	dedo del pie
dodici	doce
donna	mujer
drago	dragón
due	dos
erba	hierba
estate	verano
felice	feliz
figlia	hija
figlio	hijo
finestra	ventana
fiore	flor
fiume	río
forbice	tijera
forcella	tenedor
formaggio	queso

formula 1	fórmula 1
fornello	horno
forno	estufa
fragola	fresa
frigorifero	refrigerador
fungo	hongo
gallo	gallo
gamba	pierna
gatto	gato
giacca	chaqueta
gondola	góndola
gondoliere	gondolero
gonna	falda
grappolo d'uva	uvas
guanto	guante
innamorato, innamorata	enamorado/enamorada
insalata	ensalada
insalata mista	ensalada mezclada
inverno	invierno
jeans	vaqueros
kiwi	kiwi
lampada	lámpara
latte	leche
lavandino	lavabo
lavapiatti	lavaplatos

lavatrice	lavadora
lepre	liebre
lettera	carta
letto	calma
libro	libro
lido	playa
limone	limón
luna	luna
madre	madre
mafioso	gángster
mano	mano
manzo	buey
mare	mar
materasso	colchón
matita	lápiz
mela	manzana
melone	melón
microonda	microonda
mignolo	dedo meñique
moneta	dinero
mouse	ratón del ordenador
mutandina	calzoncillo
naso	nariz
nove	nueve
nube	nube

occhiali	gafas
occhio	ojo
oliva	oliva
onda	ola
orecchio	oreja
orologio da polso	reloj de pulsera
ostrica	ostra
otto	ocho
padella	cazuela
padre	padre
palla	balón
palma	palma
pancia	panza
pane	pan
papa	papa
parapioggia	paraguas
parasole	quitasol
penna biro	lapicero
pennello	cepille
pentola	caldero
pepe	pimiento
peperoncino	guindilla
pera	pera
pesce	pescado
piangere	llorar

pianta	planta
piatto	plato
piede	pie
pioggia	lluvia
pistola mitragliatrice	metralleta
pittore	pintor
pizza	pizza
pneumatico	neumático
pollice	pulgar
poltrona	sillón
pomodoro	tomate
ponte	puente
porco	cerdo
porta	puerta
presa	base
primavera	primavera
primo posto	1er Lugar
prosciutto	jamón
punto di arrivo	fin
quattro	cuatro
ratto	rata
recinto	alambrada
remo	remo
ridere	reír
rosa	rosa

rubinetto	grifo
sacco da montagna	mochila
salame	salami
sale	sal
salsa di pomodoro	salsa de tomate
sandalo	sandalia
scarpa	zapato
scarpa con tacco a spillo	zapato de tacón alto
scarpa di ginnastica	bamba
schermo	pantalla
sciarpa	bufanda
scimmia	mono
scopino del gabinetto	escobilla de retrete
scrivania	buró
secondo posto	2 º Lugar
sei	seis
semaforo	semáforo
serpe	serpiente
sette	siete
sigaro	cigarro
sofà	sofá
sole	sol
sopracciglio	ceja
sorpreso/sorpresa	sorprendido/sorprendida
spaghetti	espagueti

spazzola per capelli	cepillo
spazzolino da denti	cepillo de dientes
specchio	espejo
spettatori	espectadores
stella	estrella
stereo	aparato de música
stivale	bota
strada	calle
tastiera	teclado
tavolino	mesa auxiliar
tè	té
telecomando	telecomando
telefonino	móvil
telefono	telefónico
televisore	televisión
terzo posto	3er lugar
tetto	techo
tigre	tigre
timbro	estampilla
tiramisu	Tiramisu
toilette	servicio
tovagliolo	servilleta
tre	tres
triste	triste
trunks	trancos
t-shirt	camiseta
uccello	pájaro
undici	once
uno	uno
uomo	hombre
valigia	maleta
vaso	florero
vestito	vestido
vino	vino
vongola	almeja
zucchero	azúcar
zuppa	sopa

pie de imprenta

Copyright © Evi Poxleitner

Evi Poxleitner
Altmannstr. 11
80686 Múnich
Alemania

Todos los derechos, incluido el derecho de reproducción, distribución y están reservados al autor (Evi Poxleitner). Ninguna parte de esta publicación puede ser reproducida

Formulario (incluyendo la grabación de fotocopia o cualquier otro) sin el consentimiento previo por escrito

El permiso del autor (Evi Poxleitner) difundidos a través de sistemas electrónicos

ser almacenada, procesada, copiado o distribuido.

Si te gustó el libro, usted también podría estar interesado en los siguientes libros:

CHINO ★ ★ ★ ★
SIMPLEMENTE



**PINYIN/
ESPAÑOL**

(EL DRAGÓN)
LÓNG



**DICCIONARIO
EN IMÁGENES**

http://www.amazon.de/Simplemente-Chino-Diccionario-Im%C3%A1genes-ebook/dp/B0078BFLJ4/ref=sr_1_9?ie=UTF8&qid=1333043404&sr=8-9